



Specification for Structural Joints Using High- Strength Bolts

.....

June 11, 2020

Supersedes the August 1, 2014

Specification for Structural Joints Using High-Strength Bolts

Prepared by RCSC Committee A.1—Specifications and
approved by the Research Council on Structural Connections

Specification for Structural Joints Using High- Strength Bolts

.....

June 11, 2020

Supersedes the August 1, 2014

Specification for Structural Joints Using High-Strength Bolts

Prepared by RCSC Committee A.1—Specifications and
approved by the Research Council on Structural Connections



www.boltcouncil.org
RESEARCH COUNCIL ON STRUCTURAL CONNECTIONS
c/o AISC, 130 E Randolph Street, Suite 2000, Chicago, Illinois 60601

© RCSC 2020
by
Research Council on Structural Connections

All rights reserved. This book or any part thereof must not be reproduced in any form without the written permission of the publisher.

The information presented in this publication has been prepared in accordance with recognized engineering principles and is for general information only. While it is believed to be accurate, this information should not be used or relied upon for any specific application without competent examination and verification of its accuracy, suitability, and applicability by a licensed professional engineer, designer, or architect. The publication of the material contained herein is not intended as a representation or warranty on the part of the Research Council on Structural Connections or of any other person named herein, that this information is suitable for any general or particular use or of freedom from infringement of any patent or patents. Anyone making use of this information assumes all liability arising from such use.

Caution must be exercised when relying upon other specifications and codes developed by other bodies and incorporated by reference herein since such material may be modified after the printing of this edition. The Council bears no responsibility for such material it incorporates by reference at the time of the initial publication of this edition.

Printed in the United States of America

PREFACE

The purpose of the Research Council on Structural Connections (RCSC) is:

- (1) To stimulate and support such investigation as may be deemed necessary and valuable to determine the suitability, strength, and behavior of various types of structural connections;
- (2) To promote the knowledge of economical and efficient practices relating to such structural connections; and
- (3) To prepare and publish related specifications and such other documents as necessary to achieve its purpose.

The Council membership consists of qualified structural engineers from academic and research institutions, practicing design engineers, representatives of *suppliers* and *manufacturers of bolting components*, steel fabricators, steel erectors, *contractors*, associations, and code-writing bodies.

The first Specification approved by the Council, called the *Specification for Assembly of Structural Joints Using High Tensile Steel Bolts*, was published in January 1951. Since that time the Council has published 18 successive editions. Each was developed through the deliberations and approval of the full Council membership and based upon past successful usage, advances in the state of knowledge, and changes in engineering design practice. This edition of the Council's *Specification for Structural Joints Using High-Strength Bolts* continues the tradition of earlier editions. The most significant changes are listed below.

1. Significant additions to Glossary (bolting assembly, bolting component, bolt tension measurement device, calibrated gap, cure, initial tension, initial torque, job inspection gap, matched bolting assembly, spline end, sufficient thread engagement).
2. Discussion of thermal break joints in commentary.
3. Expanded list of items to be addressed by engineer of record (EOR) in commentary.
4. Addition of 144 ksi, ASTM F3148 matched bolting assemblies.
5. Adoption of "Group" 120, 144, and 150 to categorize bolt strengths.
6. Short fully threaded bolts are to be designed with threads in the shear plane. (Table 2.5).
7. Expanded discussion of "alternative design" bolting components, bolting assemblies, and *pretensioning methods* (2.12).
8. Removed requirement and prohibits hand wire brushing of galvanized faying surfaces in slip-critical joints.
9. Added ASTM A1059 coating for DTIs.
10. Added zinc-aluminum coatings, ASTM F2833 and ASTM F3019.
11. Expanded discussion of storage and lubrication (2.10).
12. Moved discussion of "*reuse*" to new and expanded section (2.11).
13. Increased standard bolt hole diameter and slot widths for bolts 1-in. in diameter and greater (Table 3.1).
14. Table 8.1 Minimum Bolt Pretension moved to Table 5.2 in design.
15. Revised values for pre-installation verification testing and for *pretension* for Group 120 bolts larger than 1 in. diameter (Table 5.2).

16. Revised tolerance for turn-of-nut (Table 8.1).
17. Corrected figure for DTI installation and washer requirements to agree with specification (Figure C-8.1, 8.2.4).
18. Clarified purpose and requirements for pre-installation verification testing (7).
19. Provided steps comprising pre-installation verification testing (7.2).
20. Provided steps for performing pretensioning using all five methods (8.2).
21. Added new “*combined method*” pretensioning method and inspection requirements for this method (8.2.5, 9.2.5).
22. Added instructions for determining required rotation when bolt length exceeds 12 bolt diameters (8.2.1 commentary).
23. Restricted the use of calibrated wrench *pretension* method to rotation of the nut (8.2.2).
24. Clarified numbers of gaps permitted and required for DTI pretensioning and inspection (8.2.4, 9.2.4).
25. Added reference to AISC *Specification for Structural Steel Buildings* Chapter N, Quality.
26. Added essential variables to Appendix A slip coefficient tests.
27. Added effective period for slip resistance test validity.

In addition, many editorial changes to the 2014 publication of the Specification are reflected in this latest edition.

The Council wishes to express their gratitude to Gian A. Rassati for his extensive and diligent work managing the changes through many revisions and multiple ballots. His service to the Council has been extraordinary and was instrumental for publication of this edition of the Specification.

By the Research Council on Structural Connections,

Officers

Salim V. Brahimi Chair	Robert Shaw Vice Chair	Jonathan McGormley Secretary/Treasurer
---------------------------	---------------------------	---

Directors

Toby Anderson	Carly McGee	Thomas J. Schlafly
Curtis L. Mayes	Gian A. Rassati	Todd C. Ude

Task Groups

1 General Requirements	Gian A. Rassati
2 Products and Parts	Toby Anderson
3 Design	James A. Swanson
4 Installation	Heath E. Mitchell/Chad M. Larson
5 Inspection	Daniel J. Kaufman

Committees

A1	Specification	Larry F. Kruth
A2/A4	Research, Education and Projects	Todd C. Ude
A3	Membership and Funding	
A5	Organizational Liaison	Salim V. Brahimi
B	Editorial	Thomas J. Schlaflly
	Staff Support	Rachel Jordan

Members

Rodney L. Baxter	Philip A. Goldsby	Brad Porter
Jason Bell	Brian Goldsmith	Randy Reagan
Peter C. Birkemoe	Matthew Haaksma	Jordan Richardson
David Bogaty	Jerome F. Hajjar	Joseph T. Ridgway
David Bornstein	Robert A Hay III	Sougata Roy
Rich Brown	Charles J. Kanapicki	Jeremy Ruggio
Garret O. Byrne	Peter F. Kasper	Michael Samuels
Chad T. Case	Daniel J. Kaufman	Ben Seinola
Derrick Castle	James S. Kennedy	Rachel Shanley
Jason Chadee	Thomas J. Langill	David F. Sharp
Helen Chen	Chad M. Larson	Victor Shneur
Robert J. Connor	Donald Livi	W. Lee Shoemaker
Bastiaan Cornelissen	Mike Marian	Nicholas Sovell
Chris Curven	John C. Marvin	Mritunjaya Srivastava
Nick E. Deal	Ronnie Medlock	Carlos Suarez Gullardo
Douglas B. Ferrell	Jinesh K. Mehta	James A. Swanson
John W. Fisher	Heath E. Mitchell	Thomas S. Tarp, Jr.
Karl H. Frank	Thomas M. Murray	Chris Thorsen
Michael C. Friel	James Neeley	Raymond H.R. Tide
Christopher Garrell	Christian Noveral	Carmen Vertullo
Albert Gelles	Justin Ocel	Dan Wrobleski
Bill Germuga	Sarah Olthof	Natasha Zamani
Rodney D. Gible	Anna Petroski	

TABLE OF CONTENTS

SYMBOLS	viii
GLOSSARY	x
Section 1. General Requirements	1
1.1. Scope	1
1.2. Loads, Load Factors, and Load Combinations	2
1.3. Design for Strength Using Load and Resistance Factor Design (LRFD)	2
1.4. Design for Strength Using Allowable Strength Design (ASD)	2
1.5. Referenced Standards and Specifications	3
1.6. Structural Design Drawings and Specifications	5
Section 2. Bolting Components and Assemblies	6
2.1. Group Designations	6
2.2. Heavy Hex Structural Bolts	8
2.3. Heavy Hex Nuts	8
2.4. Spline End Matched Bolting Assemblies	9
2.5. Washers	9
2.6. Washer-Type Indicating Devices	9
2.7. Geometry of Bolting Components and Assemblies	10
2.8. Galvanized and Coated Bolting Components and Assemblies	14
2.9. Test Reports	18
2.10. Storage and Lubrication	18
2.11. Reuse	19
2.12. Alternative-Design Bolting Components, Assemblies, and Methods	20
Section 3. Bolted Parts	23
3.1. Connected Plies	23
3.2. Faying Surfaces	23
3.3. Bolt Holes	27
3.4. Burrs	31
Section 4. Joint Type	32
4.1. Snug-Tightened Joints	34
4.2. Pretensioned Joints	35
4.3. Slip-Critical Joints	35
Section 5. Limit States in Bolted Joints	37
5.1. Nominal Shear and Tensile Strengths	38
5.2. Combined Shear and Tension	41
5.3. Nominal Bearing Strength at Bolt Holes	42
5.4. Design Slip Resistance	44
5.5. Tensile Fatigue	48

Section 6. Use of Washers	49
6.1. Snug-Tightened Joints Using Group 120, 144, or 150 Bolting Assemblies	49
6.2. Pretensioned Joints and Slip-Critical Joints Using Group 120, 144, or 150 Bolting Assemblies.	49
Section 7. Pre-Installation Verification	52
7.1. Required Testing	52
7.2. Test Procedure	54
Section 8. Installation	60
8.1. Snug-Tightened Joints	60
8.2. Pretensioned Joints and Slip-Critical Joints.	61
Section 9. Inspection	70
9.1. Snug-Tightened Joints	70
9.2. Pretensioned Joints.	70
9.3. Slip-Critical Joints	74
Section 10. Arbitration	75
Appendix A. Testing Method to Determine the Slip Coefficient for Coatings Used in Bolted Joints	77
A1. General Provisions	77
A2. Test Plates and Coating of the Specimens	79
A3. Short-Term Compression Slip Tests.	82
A4. Tension Creep Tests	88
REFERENCES	90
INDEX	94

SYMBOLS

The following symbols are used in this Specification.

A_b	Cross-sectional area based upon the nominal diameter of bolt, in. ²
D_u	Multiplier that reflects the ratio of the mean installed bolt <i>pretension</i> to the specified minimum bolt <i>pretension</i> , T_m , (see Section 5.4)
F_n	<i>Nominal strength</i> (per unit area), ksi
F_u	Specified minimum tensile strength (per unit area), ksi
F_y	Yield strength of material, ksi
H_1	Thickness of head for a heavy hex bolt, in.
H_2	Thickness of nut for a heavy hex nut, in.
I	Moment of inertia of the built-up member about the axis of buckling (see Commentary to Section 5.4), in. ⁴
L	Total length of the built-up member (see Commentary to Section 5.4), in.
L_c	Clear distance, in the direction of load, between the edge of the hole and the edge of the adjacent hole or the edge of the material, in.
L_s	For longitudinally loaded connections, length between the bolt hole centers parallel to the line of force on one side of the <i>connection</i> (see Figure C- 5.1), in.
P_u	<i>Required strength</i> in compression, kips; axial compressive force in the built-up member (see Commentary to Section 5.4), kips
Q	First moment of area of one component about the axis of buckling of the built-up member (see Commentary to Section 5.4), in. ³
R_n	<i>Nominal strength</i> , kips
R_n/Ω	<i>Allowable strength</i> , kips
$(R_n/\Omega)_t$	<i>Allowable strength</i> in tension determined in accordance with Section 5.1, kips
$(R_n/\Omega)_v$	<i>Allowable strength</i> in shear determined in accordance with Section 5.1, kips
R_s	Load to be placed on creep specimens
T	Applied service load in tension, kips
T_a	<i>Required strength</i> in tension (service tensile load) per bolt, kips
T_m	Specified minimum bolt <i>pretension</i> (for <i>pretensioned</i> joints as specified in Table 5.2), kips
T_t	Average clamping force used in coating creep tests (see Appendix A)

T_u	<i>Required strength</i> in tension (factored tensile load), kips
V_a	<i>Required strength</i> in shear (service shear load) per bolt, kips
V_u	<i>Required strength</i> in shear (factored shear load), kips
d_b	Nominal diameter of bolt, in.
d_h	Nominal diameter of bolt hole, in.
h_f	Factor for fillers (see Section 5.4)
k_s	Slip coefficient for an individual specimen determined in accordance with Appendix A
k_{sc}	Factor accounting for the presence of an applied tensile force that reduces the net clamping force (see Section 5.4)
n_b	Number of bolts in the <i>joint</i>
n_s	Number of slip planes
s	Bolt spacing in the direction of applied force, in.
t	Thickness of the connected material, in.
t'	Total thickness of fillers or shims (see Section 5.1), in.
Ω	Factor of safety
ϕ	Resistance factor
ϕR_n	<i>Design strength</i> , kips
$(\phi R_n)_t$	<i>Design strength</i> in tension determined in accordance with Section 5.1, kips
$(\phi R_n)_v$	<i>Design strength</i> in shear determined in accordance with Section 5.1, kips
μ	<i>Mean slip coefficient</i>
μ_a	Average slip coefficient from short-term slip load tests
μ_t	<i>Mean slip coefficient</i> for a long-term creep tests

GLOSSARY

The following terms are used in this Specification. Where used, they are italicized to alert the user that the term is defined in this Glossary.

Allowable Strength. The resistance to be used in ASD design; the *nominal strength*, R_n , divided by the safety factor, Ω .

Arbitration Torque. The torque used for the process of arbitration of disputes of *pretensioned* bolts (see Section 10).

Available Strength. *Design Strength* or *Allowable Strength*, as appropriate.

ASD Load. Load due to a load combination in the applicable building code intended for allowable strength design (allowable stress design).

Bolt Tension Measurement Device. A calibrated device that is used to verify that the *bolting assembly*, the *pretensioning method*, and the tools used are capable to achieve the required tensions when a *pretensioned joint* or *slip-critical joint* is specified.

Bolting Assembly. An assembly of *bolting components* that is installed as a unit.

Bolting Component. Bolt, nut, washer, *direct tension indicator* or other element used as a part of a *bolting assembly*.

Bolting Material. Rod, flat plate, bar, sheet, or forging subsequently manufactured into a *bolting component*.

Calibrated Gap. For verification testing, the average gap, measured to the nearest 0.001 in., between a *direct tension indicator* and the hardened surface on which the protrusion is bearing when a *pretension* equal to that in Table 7.1 is applied.

Coated Faying Surface. A *faying surface* that has been primed, primed and painted, or protected against corrosion, except by hot-dip galvanizing.

Connection. An assembly of one or more *joints* that is used to transmit forces between two or more members.

Cure (noun). A condition of an applied coating in which physical properties such as hardness and slip resistance are achieved.

Cure (verb). The action of changing a coating from the physical properties it had when it was applied to the physical properties it is expected to have in service.

Degree of Cure. Quantitative measurement or qualitative rating of a physical property, such as hardness, to determine the development of acceptable intended in-service properties of an applied coating.

Design Strength. ϕR_n The resistance to be used in LRFD design; the product of the *nominal strength*, R_n , and the resistance factor, ϕ .

Direct Tension Indicator. A washer-shaped device incorporating small arch-like protrusions on the bearing surface that are designed to deform in a controlled manner when subjected to a compressive load.

Engineer of Record. The party responsible for the design of the structure and for the approvals that are required in this Specification (see Section 1.6 and the corresponding Commentary).

Faying Surface. In a *connection* the contact surface between two connected elements.

Firm Contact. The condition that exists on a *faying surface* when the plies are solidly seated against each other, but not necessarily in continuous contact.

Galvanized Faying Surface. A *faying surface* that has been hot-dip galvanized.

Grip. The total thickness of material a bolt passes through, exclusive of washers or *direct-tension indicators*.

Guide. The *Guide to Design Criteria for Bolted and Riveted Joints*, 2nd Edition (Kulak et al., 1987).

High-Strength Bolt. An ASTM F3125 or F3148 bolt, or an alternative design bolt that meets the requirements in Section 2.12.

Initial Tension. Minimum bolt tension attained before application of the required rotation when using the *combined method* to *pretension bolting assemblies*.

Initial Torque. Amount of torque necessary to reach the *initial tension* in a *bolting assembly* *pretensioned* with the *combined method*.

Inspector. The party responsible to verify that the *contractor* has satisfied the provisions of this Specification in the work.

Job Inspection Gap. A gap between a *direct tension indicator* and the hardened surface on which it bears that is less than the gap measured in a *bolt tension measurement device* when a tension equal to 1.05 times the minimum required *pretension* is applied to the *bolting assembly*.

Joint. The area of a *connection* in which one weld or one group of bolting assemblies joins two or more members or *connection* elements.

Lot. A quantity of uniquely identified *bolting components* or *assemblies* or *matched bolting assemblies* of the same nominal size and length produced consecutively at the initial operation from a single mill heat of material and processed at one time, by the same process, in the same manner, so that statistical sampling is valid.

LRFD Load. Load due to a load combination in the applicable building code intended for strength design (load and resistance factor design).

Manufacturer. The party that produces one or more *bolting components*.

Matched Bolting Assembly. *Bolting Assembly* made of components that are supplied and tested by the *Manufacturer* or *Supplier* in controlled *lots* as an assembly.

Mean Slip Coefficient. μ , the ratio of the frictional shear load at the *faying surface* to the total normal force when slip occurs.

Nominal Strength. The capacity of a structure or component to resist the effects of loads, as determined by computations using the specified material strengths and dimensions and equations derived from accepted principles of structural mechanics or by field tests or laboratory tests of scaled models, allowing for modeling effects and differences between laboratory and field conditions.

Pretension (noun). A level of tensile force achieved in a *bolting assembly* through its installation, as required for *pretensioned* and *slip-critical joints*.

Pretension (verb). The act of tightening a *bolting assembly* to a level required for *pretensioned* and *slip-critical joints*.

Pretensioned Joint. A *joint* that transmits shear and/or tensile loads in which the bolts have been installed in accordance with Section 8.2 to provide a minimum specified *pretension* in the installed bolt.

Pretensioning Methods:

Calibrated Wrench Method. *Pretensioning* technique that relies upon application of an installation wrench that has been calibrated to provide the required *pretension* in a *bolting assembly*. (Section 8.2.2)

Combined Method. *Pretensioning* technique that relies upon application of an installation wrench that has been calibrated to provide the *initial torque* to attain the required *initial tension*, followed by the application of the determined relative rotation between a bolt and nut. (Section 8.2.5)

Direct Tension Indicator Method. *Pretensioning* technique that relies upon deformation of the protrusions of a *direct tension indicator*. (Section 8.2.4)

Turn-of-Nut Method. *Pretensioning* technique that relies upon application of a designated amount of relative rotation between bolt and nut. (Section 8.2.1)

Twist-Off Tension Control Bolt Method. *Pretensioning* technique that relies upon the application of torque to the nut that causes the removal of the spline by the installation wrench. (Section 8.2.3)

Protected Storage. Storage of *bolting components* or *bolting assemblies* that provides protection from environmental conditions and contamination that are detrimental to the installation of components and assemblies.

Prying Action. Lever action that exists in *connections* in which the line of application of the applied load is eccentric to the axis of the bolt, causing deformation of the fitting and an amplification of the axial tension in the bolt.

Required Strength. The load effect acting on an element or *connection* determined by structural analysis from the factored loads using the most appropriate critical load combination.

Reuse. *Pretensioning* of a *bolting assembly* that has been previously *pretensioned* and subsequently loosened.

Routine Observation. Periodic monitoring of the work in progress.

Shear/Bearing Joint. A *snug-tightened joint* or *pretensioned joint* with bolts that transmit shear loads and for which the design criteria are based upon the shear strength of the bolts and the bearing strength of the connected materials.

Slip-Critical Joint. A *joint* that transmits shear loads or shear loads in combination with tensile loads in which the *bolting assemblies* have been installed in accordance with Section 8.2 to provide a *pretension* in the installed bolt (clamping force on the *faying surfaces*), and with *faying surfaces* that have been prepared to provide a calculable resistance against slip.

Snug-Tight Condition. The *joint* condition in which the plies have been brought into *firm contact* and each *bolting assembly* has at least the tightness attained with either a few impacts of an impact wrench, resistance to a suitable non-impacting wrench, or the full effort of an ironworker using an ordinary *spud wrench*.

Snug-Tightened Joint. A *joint* in which the *bolting assemblies* have been installed to the *snug-tight condition*.

Spline End Matched Bolting Assemblies:

Fixed. A *matched bolting assembly* with a spline end that is to remain attached to the bolt once the installation is complete.

Twist-Off. A *matched bolting assembly* with a spline end that is to be sheared off by the installation wrench when using the *twist-off tension control bolt method* for installation.

Start of Work. Any time prior to the installation of *high-strength bolts* in structural connections.

Style. The physical configuration of a *high-strength bolt* or *bolting assembly* (heavy hex, twist-off)

Sufficient Thread Engagement. Having the end of the bolt, not including the spline of a spline-end bolt, or the available bolt threads extending beyond or at least flush with the outer face of the nut; a condition that develops the strength of the bolt.

Supplier. The party that sells the *bolting components* or *matched bolting assemblies*.

Temporary Bolts. *Bolting components* or *bolting assemblies* that are temporarily used in a *joint* for purposes such as alignment, fit-up, or shipping.

Touching up. Re-tightening of a bolt loosened by the tightening of adjacent bolts.

Uncoated Faying Surface. A *faying surface* that has neither been primed, painted, nor hot-dip galvanized.

SPECIFICATION FOR STRUCTURAL JOINTS USING HIGH-STRENGTH BOLTS

SECTION 1. GENERAL REQUIREMENTS

1.1. Scope

This Specification covers the design of bolted *joints* and the installation and inspection of *bolting components* and *bolting assemblies* listed in Section 1.5. The Specification also considers the use of alternative-design *bolting components, assemblies*, or installation methods as permitted in Section 2.12. This Specification relates only to those aspects of the connected materials that bear upon the performance of the bolted *joints*.

The Symbols, Glossary, and Appendix are a part of this Specification. The Commentary to this Specification that is interspersed throughout is not part of this Specification.

This Specification shall not be interpreted in a way that prevents the use of *bolting components* or *assemblies* and the use of installation methods not specifically referred to herein, provided that the requirements of Section 2.12 are satisfied.

Commentary:

This Specification covers the design of bolted *joints* with collateral materials in the *grip* that are made of steel. These provisions do not apply when materials other than steel are included in the *grip*. These provisions are not applicable to anchor rods.

Recently, other types of *joints* that contain low-modulus materials in the *grip*, and most notably thermal break joints, have made an entrance in the market and questions on their use, chiefly for components, such as cladding, awnings, and roof posts, that are not part of a primary load-resisting system, have come forward. Thermal break joints are not intended for primary load resisting systems. Several research projects have been conducted (Peterman et al., 2017; Peterman et al., 2020; Hamel and White, 2016) investigating the structural properties of thermal break joints showing that the presence within the *grip* of compressible gaskets, insulation, or other materials or coatings will preclude the development and/or retention of the installation *pretension* in the bolts.

Peterman et al. show that low-modulus materials are permissible in snug-tightened *joints* with bolts subject to shear when long-term loads are limited to 30% of the low-modulus materials' ultimate load. Low-modulus materials that showed acceptable behavior in that study had through-thickness modulus of elasticity between 400 ksi and 800 ksi and through-thickness compressive strength between 25 ksi and 65 ksi.

Additionally, with the presence of compressible materials in the *grip*, the snug-tightening operation will not generate a sufficient force in the bolt to deform the shank so that the head and/or the nut adapt to the slope of the surfaces under them. Therefore, only surfaces that are near-perpendicular to the bolt axis should be used in thermal break joints.

Based on the results in the literature, the *Engineer of Record* should consider, as a minimum, the following aspects of a thermal break joint:

- The stiffness and strength of the inserted layers and their influence on the intended performance of the joint;
- The maximum bolt tension that the layers in the *grip* can withstand without losing integrity or performance;
- The installation instructions to prevent overtightening of bolts;
- The effects of the thickness of the added plies on the stiffness and strength of the *bolting assembly* and of the *connection* as a whole;
- The resistance to exposure of the added plies, when applicable;
- The type of forces that the joint is intended to transfer (e.g., shear, shear and tension, compression, tension without fatigue);
- The long-term behavior of the inserted layers; and
- The electro-chemical interactions of the inserted layers with coatings on steel, if applicable.

1.2. Loads, Load Factors, and Load Combinations

The design and construction of the structure shall conform to either an applicable load and resistance factor design specification for steel structures or to an applicable allowable strength design specification for steel structures. Because factored load combinations account for the reduced probabilities of maximum loads acting concurrently, the *design strengths* given in this Specification shall not be increased.

1.3. Design for Strength Using Load and Resistance Factor Design (LRFD)

Design according to the provisions for load and resistance factor design (LRFD) satisfies the requirements of this Specification when the *design strength* of each structural component or *connection* element equals or exceeds the *required strength* determined on the basis of the *LRFD load* combinations.

Design shall be performed in accordance with Equation 1.1:

$$R_u \leq \phi R_n \quad (\text{Equation 1.1})$$

where

R_u = *required strength* using *LRFD load* combinations

R_n = *nominal strength*

ϕ = *resistance factor*

ϕR_n = *design strength*

1.4. Design for Strength Using Allowable Strength Design (ASD)

Design according to the provisions for allowable strength design (ASD) satisfies the requirements of this Specification when the *design strength* of each structural component or *connection* element equals or exceeds the *required strength* determined on the basis of the *ASD load* combinations.

Design shall be performed in accordance with Equation 1.2:

$$R_a \leq R_n/\Omega \quad (\text{Equation 1.2})$$

where

R_a = *required strength* using ASD load combinations

R_n = *nominal strength*

Ω = *safety factor*

R_n/Ω = *allowable strength*

Commentary:

This Specification is written in a dual format covering both load and resistance factor design (LRFD) and allowable strength design (ASD). Both approaches provide a method of proportioning structural components such that no applicable limit state is exceeded when the structure is subject to all appropriate load combinations. When a structure or structural component ceases to fulfill the intended purpose in some way, it is said to have exceeded a limit state. Strength limit states concern maximum load-carrying capability and are related to safety. Serviceability limit states are usually related to performance under normal service conditions and usually are not related to strength or safety. The term “resistance” includes both strength limit states and serviceability limit states.

Although loads, load factors, and load combinations are not explicitly specified in this Specification, the safety and resistance factors herein are based upon the loads, load factors, and load combinations specified in ASCE 7. When the design is governed by other load criteria, the safety and resistance factors specified herein should be adjusted as appropriate.

1.5. Referenced Standards and Specifications

The following standards and specifications are referenced herein:

American Institute of Steel Construction

ANSI/AISC 360-16 *Specification for Structural Steel Buildings*

American Society of Mechanical Engineers

ANSI/ASME B18.2.6-19 *Fasteners for Use in Structural Applications*

ASTM International

ASTM A123/A123M-17 *Standard Specification for Zinc (Hot-Dip Galvanized) Coatings on Iron and Steel Products*

ASTM A194/A194M-20a *Standard Specification for Carbon Steel, Alloy Steel, and Stainless Steel Nuts for Bolts for High Pressure or High Temperature Service, or Both*

ASTM A563-15 *Standard Specification for Carbon and Alloy Steel Nuts*

ASTM A1059/A1059M-18 *Standard Specification for Zinc Alloy Thermo-Diffusion Coatings (TDC) on Steel Fasteners, Hardware, and Other Products*

ASTM B695-04 (2016) *Standard Specification for Coatings of Zinc Mechanically Deposited on Iron and Steel*

- ASTM D3363-20 *Standard Test Method for Film Hardness by Pencil Test*
- ASTM D4752-20 *Standard Practice for Measuring MEK Resistance of Ethyl Silicate (Inorganic) Zinc-Rich Primers by Solvent Rub*
- ASTM F436/F436M-19 *Standard Specification for Hardened Steel Washers, Inch and Metric Dimensions*
- ASTM F959/F959M-17a *Standard Specification for Compressible-Washer-Type Direct Tension Indicators for Use with Structural Fasteners, Inch and Metric Series*
- ASTM F1136/F1136M-11 (2019) *Standard Specification for Zinc/Aluminum Corrosion Protective Coatings for Fasteners*
- ASTM F2329/F2329M-15 *Standard Specification for Zinc Coating, Hot-Dip, Requirements for Application to Carbon and Alloy Steel Bolts, Screws, Washers, Nuts, and Special Threaded Fasteners*
- ASTM F2833-11 (2017) *Specification for Corrosion Protective Fastener Coatings with Zinc Rich Base Coat and Aluminum Organic/Inorganic Type*
- ASTM F3019/F3019M-19 *Standard Specification for Chromium Free Zinc-Flake Composite, with or without Integral Lubricant, Corrosion Protective Coatings for Fasteners*
- ASTM F3125/F3125M-19 *Standard Specification for High Strength Structural Bolts and Assemblies, Steel and Alloy Steel, Heat Treated, Inch Dimensions 120 ksi and 150 ksi Minimum Tensile Strength, and Metric Dimensions 830 MPa and 1040 MPa Minimum Tensile Strength*
- ASTM F3148-17a *Standard Specification for High Strength Structural Bolt Assemblies, Steel and Alloy Steel, Heat Treated, 144ksi Minimum Tensile Strength, Inch Dimensions*
- ASTM F3393-20e1 *Standard Specification for Zinc-Flake Coating Systems for Fasteners*

American Society of Civil Engineers

ASCE/SEI 7-16 *Minimum Design Loads and Associated Criteria for Buildings and Other Structures*

IFI: Industrial Fastener Institute

IFI 144-2000 (R2013) *Test Evaluation Procedures for Coating Qualification Intended for Use on High-Strength Structural Bolts*

SSPC: The Society for Protective Coatings

SSPC-PA2 (11/1/2018) *Procedure for Determining Conformance to Dry Coating Thickness Requirements*

Commentary:

Dual-unit standards are cited only by the U.S. Customary standard name in this specification.

1.6. Structural Design Drawings and Specifications

The *Engineer of Record* shall specify the following information in the contract documents:

- (1) The Group designation (Section 2.1) of bolt or *bolting assembly* and steel type (Section 2 Commentary) to be used;
- (2) The *joint* type (Section 4); and
- (3) The required class of slip resistance if *slip-critical joints* are specified (Section 4).

Commentary:

A summary of additional information that the *Engineer of Record* may specify, may require the Engineer's attention, or may require the Engineer's approval is provided below. The parenthetical reference after each listed item indicates the location of the referenced item in this Specification.

- (1) *Bolting assembly* grade, type (type 1 or type 3), *style* (heavy hex or twist-off), coating (hot-dip galvanized, mechanically galvanized, etc.), and any other considerations on special components or installation methods related to the *bolting assembly* (Section 2);
- (2) Specifying when threads must be excluded from the shear plane, if applicable (Section 5);
- (3) Use of *faying surface* coatings in *slip-critical joints* that provide a *mean slip coefficient* determined in accordance with Appendix A, but differing from Class A or Class B coatings (Section 3.2.2(2));
- (4) Use of any materials other than steel within the *joint* (outside of the scope of the Specification, discussed in Commentary to Section 1.1);
- (5) Use of alternative-design *bolting components, assemblies*, or installation methods, including the corresponding installation and inspection requirements that are provided by the *Manufacturer* (Section 2.12);
- (6) *Reuse* of bolts (Section 2.11);
- (7) If *re-pretensioning* of galvanized *bolting assemblies* is required by the *Engineer of Record*, this must be clearly specified in the contract documents (see Commentary to Section 8.2);
- (8) Use of thermal cutting of bolt holes produced free hand or for use in cyclically loaded *joints* (Section 3.3);
- (9) Use of oversized (Section 3.3.2), short-slotted (Section 3.3.3), or long slotted holes (Section 3.3.4) in lieu of standard holes;
- (10) Use of a value of D_u other than the value provided in Section 5.4;
- (11) Restrictions on the use of hole types (Section 3.3);
- (12) Use of hole sizes larger than permitted in Section 3.3.

SECTION 2. BOLTING COMPONENTS AND ASSEMBLIES

2.1. Group Designations

This Specification addresses three tensile strength levels of bolts and categorizes the *bolting component* or *bolting assembly* by Group, as shown in Table 2.1.

Table 2.1			
Group Designations for Bolts and Matched Bolting Assemblies			
Group	Tensile Strength	Bolts	Matched Bolting Assemblies
Group 120	120 ksi	ASTM F3125 Grade A325	ASTM F3125 Grade F1852
Group 144	144 ksi	—	ASTM F3148 Grade 144
Group 150	150 ksi	ASTM F3125 Grade A490	ASTM F3125 Grade F2280

Commentary:

This Specification deals principally with *high-strength bolts* in three tensile strengths—120, 144, and 150 ksi; their design, installation, inspection, and performance in structural steel *joints*, and those few aspects of the connected material that affect performance. Many other aspects of *connection* design and fabrication are of equal importance and must not be overlooked. For more general information on design and issues related to *high-strength bolting* and the connected material, refer to current steel design textbooks and the *Guide to Design Criteria for Bolted and Riveted Joints*, 2nd Edition (Kulak et al., 1987).

For convenience, this specification identifies these tensile strength levels as Groups and categorizes the bolt or *bolting assembly* as shown in Table 2.1.

ASTM structural bolt standards currently provide for two types of *high-strength bolts*, according to metallurgical classification. Type 1 bolts may be manufactured from medium carbon steel, carbon boron steel, alloy steel, or alloy steel with added boron. Type 3 bolts have improved atmospheric corrosion resistance and weathering characteristics. When the bolt type is not specified, either Type 1 or Type 3 may be supplied at the *Manufacturer's* option.

Structural bolts addressed in this Specification are supplied in diameters from ½ in. through 1½ in. Not all styles are available in all diameters.

Structural bolts, nuts, and washers are required by ASTM standards to be distinctively marked. In addition to mandatory marks, the *Manufacturer* may apply additional distinguishing marks. The mandatory marks are illustrated in Figure C-2.1.

This Specification contains provisions for approval by the *Engineer of Record* of alternative-design bolts and *bolting assemblies*. See the requirements in Section 2.12.















Bolt/Nut/Washer/Matched Bolt Assembly	Type 1	Type 3
ASTM F3125 Grade A325 bolt		
ASTM F3125 Grade F1852 bolt		
ASTM F3125 Grade A490 bolt		
ASTM F3125 Grade F2280 bolt		
ASTM F3148 Grade 144 bolt		
ASTM A563 nut	 Arcs indicate Grade C	 Arcs with "3" indicate Grade C3
	 Grade D	
	 Grade DH	 Grade DH3

Figure C-2.1. Required marks for acceptable bolt and nut components. (cont'd.)

<p>ASTM F436 washers</p>		
<p>ASTM F959 Direct Tension Indicators for Group 120</p>		
<p>ASTM F959 Direct Tension Indicators for Groups 144 and 150</p>		
<p>1. XYZ represents the <i>Manufacturer's</i> identification mark. 2. <i>Spline end matched bolting assemblies</i> made to ASTM F3125 Grades F1852 and F2280 may be produced with heavy hex heads and have similar marks.</p>		

Figure C-2.1. Required marks for acceptable bolt and nut components. (cont'd.)

2.2. Heavy Hex Structural Bolts

Group 120 and 150 heavy hex structural bolts shall meet the requirements of ASTM F3125 Grades A325 and A490, respectively. The *Engineer of Record* shall specify the ASTM designation, grade, type, and coating of the bolt to be used.

2.3. Heavy Hex Nuts

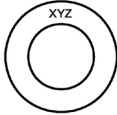
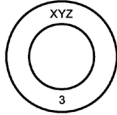
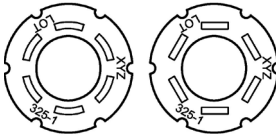
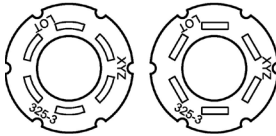
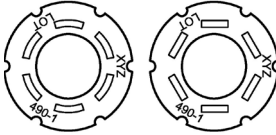
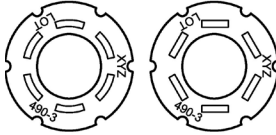
2.3.1. Heavy hex nuts shall meet the requirements of ASTM A563, except as noted in 2.3.2. The grade of such nuts shall be as given in Table 2.2. When coated to the standards listed in Section 2.8, nuts shall be overtapped in accordance with Table A1.2 of ASTM F3125.

2.3.2. ASTM A194 Grade 2H nuts are permitted as substitutes for ASTM A563 Grade DH nuts.

<p align="center">Table 2.2 Permitted Nut Grades</p>			
<p>Group Designation</p>	<p>Bolt Type</p>	<p>Coating</p>	<p>ASTM A563 Nut Grade</p>
<p align="center">120</p>	<p align="center">1</p>	<p align="center">Plain</p>	<p align="center">C, C3, D, DH, and DH3</p>
		<p align="center">Coated in compliance with 2.8</p>	<p align="center">DH</p>
	<p align="center">3</p>	<p align="center">Plain</p>	<p align="center">C3 and DH3</p>
<p align="center">144 and 150</p>	<p align="center">1</p>	<p align="center">Plain</p>	<p align="center">DH and DH3</p>
		<p align="center">Coated in compliance with 2.8</p>	<p align="center">DH</p>
	<p align="center">3</p>	<p align="center">Plain</p>	<p align="center">DH3</p>

Commentary:

ASTM A563 nuts are manufactured to dimensions as specified in ASME B18.2.6. The basic dimensions are listed in Table C-2.1 and illustrated in Figure C-2.2.

Nuts for use with plain Grade 150 bolts are often specified with lubricant to reduce the effort required to tighten the bolts and to increase their elongation during installation.

2.4. Spline End Matched Bolting Assemblies

- 2.4.1. Group 120 and 150 *spline end twist-off matched bolting assemblies* shall meet the requirements of ASTM F3125 Grade F1852 and Grade F2280, respectively. The *Engineer of Record* shall specify the designation, grade, type, and coating of the *matched bolting assembly* to be used. See Section 2.8.

Commentary:

ASTM F3125 Grades F1852 and F2280 *spline end twist-off matched bolting assemblies* may be manufactured with a round head or a heavy hex head.

- 2.4.2. Group 144 *spline end fixed matched bolting assemblies* shall meet the requirements of ASTM F3148 Grade 144. The *Engineer of Record* shall specify the grade, type, and coating of the *matched bolting assembly* to be used. See Section 2.8.

2.5. Washers

Flat circular washers and beveled washers shall meet the requirements of ASTM F436, except as provided in Table 6.1. The type (Type 1 or Type 3) of such washers shall be the same as the bolt.

2.6. Washer-Type Indicating Devices

Compressible-washer-type *direct tension indicators* shall meet the requirements of ASTM F959. The type of *direct tension indicators* shall be as given in Table 2.3.

Group Designation	Bolt Type	DTI Type
Group 120	1	ASTM F959, Type 325-1
	3	ASTM F959, Type 325-3
Group 144	1	ASTM F959, Type 490-1
	3	ASTM F959, Type 490-3
Group 150	1	ASTM F959, Type 490-1
	3	ASTM F959, Type 490-3

Commentary:

ASTM F959 requires that coatings other than mechanically galvanized zinc and thermally diffused zinc are to be used only when approved by the *Manufacturer*.

Because of common installation tension requirements, Group 150 *direct tension indicators* are appropriate for installation with Group 144 *bolting components*.

2.7. Geometry of Bolting Components and Assemblies

Bolting components and *assemblies* shall meet the dimensional requirements shown in Table 2.4. The bolt length used shall be such that, when installed, *sufficient thread engagement* (as defined in the Glossary) is achieved.

Table 2.4	
Dimensional Requirements for Bolting Components and Assemblies	
Bolting Component or Assembly	Dimensional Standard
Group 120 and 150 heavy hex bolt	ASME B18.2.6
Group 120 and 150 <i>spline end twist-off matched bolting assembly</i>	ASME B18.2.6
Group 144 heavy hex bolt Group 144 <i>spline end fixed matched bolting assembly</i>	ASTM F3125 ASME B18.2.6 except for spline dimensions
ASTM A563 heavy hex nut ASTM A194 heavy hex nut	ASME B18.2.6 ASME B18.2.2
ASTM F436 washer	ASTM F436
ASTM F959 <i>direct tension indicator</i>	ASME B18.2.6

Table 2.5	
Bolt Lengths Required to Be Fully Threaded in Accordance with ASME B18.2.6	
Nominal Bolt Diameter, d_b, in.	Bolt Length, L, in.
$\frac{1}{2}$	$1\frac{1}{4}$
$\frac{5}{8}$	$L \leq 1\frac{1}{2}$
$\frac{3}{4}$	$L \leq 1\frac{3}{4}$
$\frac{7}{8}$	$L \leq 2$
1	$L \leq 2\frac{1}{4}$
$1\frac{1}{8}$ & $1\frac{1}{4}$	$L \leq 2\frac{3}{4}$
$1\frac{3}{8}$ & $1\frac{1}{2}$	$L \leq 3\frac{1}{4}$

Commentary:

Structural bolts are manufactured to the dimensions specified in ASME B18.2.6. The basic dimensions are listed in Table C-2.1 and illustrated in Figure C-2.2.

The principal geometric features of heavy hex structural bolts that distinguish them from bolts for general applications are the head size and the unthreaded body length. Heavy hex structural bolt heads have the same width-across-flat dimensions as heavy hex nuts so that an ironworker may use the same wrench or socket on either the bolt head or the nut.

With the specific exception of fully threaded bolts and the other permitted variances discussed below, heavy hex structural bolts have shorter threaded lengths than bolts for general applications. By making the body length of the bolt the control dimension, it is possible to exclude the bolt threads from all shear planes when desirable (except in cases of thin plies adjacent to the nut).

The shorter threaded lengths provided with heavy hex structural bolts tend to minimize the threaded portion of the bolt within the *grip*. Accordingly, care must be exercised to provide adequate threaded length between the nut and the bolt head to enable appropriate installation without jamming the nut on the thread run-out.

Depending upon the length increments of supplied bolts, for a *bolting assembly* without washers, the full thread of a bolt may extend into the *grip* as far as $\frac{3}{8}$ in. for $\frac{1}{2}$ -, $\frac{5}{8}$ -, $\frac{3}{4}$ -, $\frac{7}{8}$ -, $1\frac{1}{4}$ - and $1\frac{1}{2}$ -in. diameter bolts, and as far as $\frac{1}{2}$ in. for 1, $1\frac{1}{8}$, and $1\frac{3}{8}$ in. diameter bolts. When the thickness of the ply closest to the nut is less than these dimensions, it may still be possible to exclude the threads from the shear plane, when required, depending upon the specific combination of bolt length, *grip*, and number of washers used under the nut (Carter, 1996). If necessary, the next increment of bolt length can be specified along with ASTM F436 washers in sufficient quantity to both exclude the threads from the shear plane and ensure that the *bolting assembly* can be properly installed with adequate threads included in the *grip*.

At maximum accumulation of tolerances from all components in the *bolting assembly*, the thread run-out may cross the shear plane for the critical combination of bolt length and *grip* used to select the foregoing rules of thumb for ply thickness required to exclude the threads. Previous editions of this Specification treated shear planes in the thread transition length (see dimension *Y* in Figure C-2.2) as if the threads were excluded. Recent evaluation of this transition area and the variations permitted by ASME B18.2.6 (Swanson et al., 2020a,b) have caused the more conservative approach taken in this edition. See Section 5.1.

There are exceptions to the standard thread length requirements for F3125 Grades A325 and A490 bolts, Grades F1852 and 2280 *matched bolting assemblies*, and F3148 Grade 144 *matched bolting assemblies*. First, ASME B18.2.6 requires that bolts shorter than certain lengths be fully threaded. (Table 2.5 lists such bolt lengths, which vary by diameter.) However, due to different *Manufacturers'* production methods the threads on such short bolts may not reach completely to the head and thus may leave the appearance of a usable shank or full-diameter body. Since any such appearance may differ and its presence cannot be predicted reliably, for certain *joints* with thin plies where such short, fully threaded bolts are used, the *Engineer of Record* should assume that no usable shank or full-body diameter exists and should assume that in such *joints* any shear planes will cross the bolt threads. Additional information on this approach can be found in Swanson et al. (2020a,b).

Secondly, optional supplementary requirements for ASTM F3125 Grade A325 and F3148 bolts permit the purchaser to specify bolts that are threaded for the full length of the shank if the nominal length of the bolt is equal to or less than four times its nominal diameter. This option is provided to increase economy through simplified ordering and inventory control in the fabrication and erection of structures. It is particularly useful in those structures in which the strength of the *connection* is dependent upon the bearing strength of relatively thin connected material rather than the shear strength of the bolt, whether with threads in the shear plane or not. ASTM F3125 and ASTM F3148 require that bolts ordered to such supplementary requirements be marked with the symbol "T".

Lastly, optional supplementary requirements in ASTM F3125 permit the purchaser to specify threads of any length when necessary. ASTM F3125 requires that such bolts are to be marked with an "S". Such special thread lengths are produced only when specifically ordered.

To determine the required bolt length, the value shown in Table C-2.2 should be added to the *grip* (i.e., the total thickness of all connected material, exclusive of washers). For each ASTM F436 washer that is used, add $\frac{5}{32}$ in.; for each beveled washer, add $\frac{5}{16}$ in. The tabulated values provide for manufacturing tolerances and *sufficient thread engagement* with a heavy hex nut. The length determined by the use of Table C-2.2 should be adjusted to the nearest $\frac{1}{4}$ -in. increment (or $\frac{1}{2}$ -in. increment for lengths exceeding 6 in.). A more extensive table for bolt length selection based upon these rules is available (Carter, 1996; Swanson et al., 2020a).

Table C-2.1
Heavy Hex Bolt and
Nut Nominal Dimensions

Nominal Bolt Diameter, d_b	Heavy Hex Bolt Dimensions, in. ^a				Heavy Hex Nut Dims., in. ^b	
	Width across Flats, F	Height, H_1	Thread Length, L_T ^c	Transition Thread Length, Y	Width across Flats, W	Height, H_2
$\frac{1}{2}$	$\frac{7}{8}$	$\frac{5}{16}$	1	$\frac{3}{16}$	$\frac{7}{8}$	$\frac{31}{64}$
$\frac{5}{8}$	$1\frac{1}{16}$	$\frac{25}{64}$	$1\frac{1}{4}$	$\frac{7}{32}$	$1\frac{1}{16}$	$\frac{39}{64}$
$\frac{3}{4}$	$1\frac{1}{4}$	$\frac{15}{32}$	$1\frac{3}{8}$	$\frac{1}{4}$	$1\frac{1}{4}$	$\frac{47}{64}$
$\frac{7}{8}$	$1\frac{7}{16}$	$\frac{35}{64}$	$1\frac{1}{2}$	$\frac{9}{32}$	$1\frac{7}{16}$	$\frac{55}{64}$
1	$1\frac{5}{8}$	$\frac{39}{64}$	$1\frac{3}{4}$	$\frac{5}{16}$	$1\frac{5}{8}$	$\frac{63}{64}$
$1\frac{1}{8}$	$1\frac{13}{16}$	$1\frac{1}{16}$	2	$1\frac{1}{32}$	$1\frac{13}{16}$	$1\frac{7}{64}$
$1\frac{1}{4}$	2	$\frac{25}{32}$	2	$\frac{3}{8}$	2	$1\frac{7}{32}$
$1\frac{3}{8}$	$2\frac{3}{16}$	$\frac{27}{32}$	$2\frac{1}{4}$	$\frac{7}{16}$	$2\frac{3}{16}$	$1\frac{11}{32}$
$1\frac{1}{2}$	$2\frac{3}{8}$	$\frac{15}{16}$	$2\frac{1}{4}$	$\frac{7}{16}$	$2\frac{3}{8}$	$1\frac{15}{32}$

^a See ASME B18.2.6 Table 2.1-1 for additional dimensional information.
^b See ASME B18.2.6 Table 3.1-1 for additional dimensional information.
^c See Commentary to Section 2.7 for other thread length configurations.

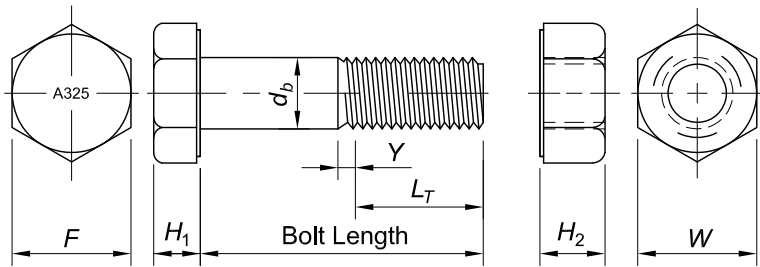

Nut may be chamfered on both faces

Figure C-2.2. Heavy hex structural bolt and heavy hex nut.

Table C-2.2 Bolt Length Selection	
Nominal Bolt Diameter, d_b , in.	To Determine the Required Bolt Length, Add to <i>Grip + Washer + Direct tension indicator</i> , in.
$\frac{1}{2}$	$\frac{1}{16}$
$\frac{5}{8}$	$\frac{7}{8}$
$\frac{3}{4}$	1
$\frac{7}{8}$	$1\frac{1}{8}$
1	$1\frac{1}{4}$
$1\frac{1}{8}$	$1\frac{1}{2}$
$1\frac{1}{4}$	$1\frac{5}{8}$
$1\frac{3}{8}$	$1\frac{3}{4}$
$1\frac{1}{2}$	$1\frac{7}{8}$

2.8. Galvanized and Coated Bolting Components and Assemblies

2.8.1. Galvanized Coating Components

Group 120 and Group 144 *bolting components* are permitted to be hot-dip or mechanically galvanized, except that *direct tension indicators* are only permitted to be mechanically galvanized in compliance with ASTM F959.

Hot-dip galvanized *bolting components* shall meet the requirements of ASTM F2329. Mechanically galvanized *bolting components* shall meet the Class 55 requirements of ASTM B695. All threaded components of the *bolting assembly* shall be galvanized by the same process.

Mechanical galvanizing of *spline-end twist-off* and *fixed matched bolting assemblies* shall be performed only under the direction of the *Manufacturer* and as permitted by their respective standards. Hot-dip galvanizing of *spline-end matched bolting assemblies* is not permitted.

Hot-dip or mechanical galvanizing of Group 150 heavy hex bolts or Group 150 *spline-end matched bolting assemblies* is not permitted.

Commentary:

ASTM Specifications permit the galvanizing of ASTM F3125 Grade A325 bolts. Applying zinc to Grade A490 bolts by galvanizing, metallizing, or mechanical coating is not permitted because its effects on embrittlement and delayed cracking have not been fully investigated to date. Research is in progress into whether this prohibition can be repealed.

Galvanizing or coating *bolting components* affects the stripping strength of the *bolting assembly*. To accommodate the variation in coating thickness on bolt threads, it is usual practice when coating *bolting components* to tap the nut oversize (or “overtap”). This results in a reduction of thread engagement with a consequent reduction of the stripping strength. It is important that the specified proof load of the nut be higher than the tensile strength of the bolt. Only the hardened nut grades have adequate strength after overtapping to meet ASTM structural bolt strength requirements. Therefore, only ASTM A563 Grades DH and DH3 and ASTM A194 Grade 2H nuts are suitable for use as galvanized nuts.

Galvanized *high-strength bolts* and nuts must be considered as a *matched bolting assembly*, and three principal factors must be considered so that the provisions of this Specification are understood and properly applied. These are:

- (1) The effect of the galvanizing process on the mechanical properties of high-strength *bolting materials*;
- (2) The effect of overtapping galvanized nuts on the nut’s stripping strength; and
- (3) The effect of galvanizing and lubrication on the torque required for *pretensioning*.

Birkemoe and Herrschaft (1970) showed that, in the as-galvanized condition, galvanizing increases the friction between the bolt and nut threads as well as the variability of the torque-induced *pretension*. A lower required torque and more consistent results are obtained if the nuts are lubricated. Thus, ASTM F3125 requires that a galvanized bolt and a galvanized and lubricated nut be assembled in a steel *joint* with an equivalently coated washer and tested by the *Supplier* prior to shipment. This testing, called rotational capacity (or “rocap”) testing, must show that the galvanized nut with the lubricant provided may be rotated from the *snug-tight condition* well in excess of the rotation required for *pretensioned* installation without stripping. This requirement applies to hot-dip galvanized and mechanically galvanized *bolting assemblies*. The above requirements clearly indicate that:

- (1) Galvanized *high-strength bolts* and nuts must be treated as a *matched bolting assembly*; and
- (2) The *Supplier* must supply nuts that have been lubricated and tested with the supplied bolts.

The purchase of galvanized *high-strength bolts* and nuts from separate *Suppliers* is not in accordance with the intent of ASTM F3125 because the *Supplier* responsibility for the performance of the *bolting assembly* clearly could not have been provided as required.

Because some of the lubricants used to meet the requirements of ASTM standards are water soluble, it is advisable that galvanized *high-strength bolts* and nuts be shipped and stored in sealed metal or plastic containers. Containers of *bolting components* with wax-type lubricants should not be subjected to heat that would cause depletion or change in the properties of the lubricant.

ASTM F3125 allows for both hot-dip galvanizing (ASTM F2329) and mechanical galvanizing (ASTM B695). The effects of the two coating processes on the performance characteristics and installation requirements are different. In accordance with ASTM F3125, all threaded components of the *bolting assembly* must be galvanized by the same process. (The *Supplier's* option is limited to one process per item with no mixed processes in a *lot*.) Mixing *high-strength bolts* that are galvanized by one process with nuts that are galvanized by the other may result in an unworkable *bolting assembly*.

Steels with tensile strength of 200 ksi and higher are subject to embrittlement if hydrogen is permitted to remain in the steel and the steel is subjected to high tensile stress. The minimum tensile strength of ASTM F3125 Grades A325 and F1852 bolts is 120 ksi, while the minimum for ASTM F3148 bolts is 144 ksi. Maximum hardness limits result in production tensile strengths well below the critical range. The minimum tensile strength for ASTM F3125 Grades A490 and F2280 bolts is 150 ksi and in addition, a maximum tensile strength limit of 173 ksi is specified to provide a margin below 200 ksi. The hardness maximum of 38 HRC for ASTM F3125 Grade A490 bolts provides a safeguard against hydrogen embrittlement. However, because *Manufacturers* must target their production slightly higher than the required minimum, Grades A490 and F2280 bolts close to the critical range of tensile strength must be anticipated. For plain finish *high-strength bolts*, this is not a cause for concern. However, if the bolt is hot-dip galvanized, delayed brittle fracture in service is a concern because of the possibility of the introduction of hydrogen during the pickling operation of the hot-dip galvanizing process and the subsequent “sealing-in” of the hydrogen by the zinc coating. There also exists the possibility of cathodic hydrogen absorption arising from the corrosion process in certain aggressive environments.

2.8.2. Coated Bolting Components and Assemblies not including Direct Tension Indicators

Zinc aluminum inorganic coatings complying with ASTM F1136, ASTM F2833 and ASTM F3019 are permitted to be applied prior to installation, in accordance with Table 2.6.

Table 2.6			
Permitted Coatings for Bolts, Nuts and Washers			
Specification	Bolt	Nut	Washer
ASTM F1136	Grade 3	Grade 5	Grade 3
ASTM F2833		Grade 1	
ASTM F3019		Grade 4	

Coating of *spline-end twist-off* and *fixed-matched bolting assemblies* shall be performed only under the direction of the *Manufacturer* and as permitted by the assemblies' respective standards.

When Group 120 and Group 150 bolts are coated to the standards listed in Table 2.6, nuts shall be overtapped in accordance with Table A1.2 of ASTM F3125. For Group 144 *matched bolting assemblies*, nuts shall be overtapped in accordance with Table 1 of ASTM F3148.

The *Engineer of Record* is permitted to approve other coatings that have been approved by ASTM for use on *bolting components* or *matched bolting assemblies* between published editions of this Specification.

Commentary

Despite the thin film of the Zn/Al coatings, overtapping the nuts may be necessary. Similar to mechanical galvanizing, such a process results in a comparatively uniform and evenly distributed coating.

Coated *high-strength bolts* and nuts must be considered as a *matched bolting assembly*, and three principal factors must be considered so that the provisions of this Specification are understood and properly applied. These are:

- (1) The effect of the coating process on the mechanical properties of *bolting materials*;
- (2) The effect of overtapping coated nuts on the nut's stripping strength; and
- (3) The effect of coating and lubrication on the torque required for *pretensioning*.

Coatings in Table 2.6 have been tested to indicate they will not degrade the performance of Group 150 bolts due to selected conditions. Inclusion in that table does not imply any specific corrosion protection performance.

ASTM F3393, *Zinc-Flake Coating Systems for Fasteners*, was adopted by ASTM after preparation of this edition of this RCSC Specification. It is a consolidation and replacement of the three ASTM zinc-flake coating standards cited in this section (i.e., ASTM F1136, ASTM F2833, and ASTM F3019). Users of this RCSC Specification should be aware that ASTM F3393, and the subsequent withdrawal of the three current zinc-flake coating systems currently listed above, will require additional consideration when such coating systems are specified.

Investigations in accordance with IFI-144 were completed and presented to the ASTM F16 Committee on Fasteners (Brahimi, 2006, 2011, 2014, 2017). These investigations demonstrated that a Zn/Al Inorganic Coating applied in accordance with the relevant standards to ASTM F3125 Grade A490 bolts does not cause delayed cracking by internal hydrogen embrittlement, nor does it accelerate environmental hydrogen embrittlement by hydrogen absorption. Thus, this is an acceptable finish to be used on such bolts.

Although these bolts are typically not used in this manner, the *Engineer of Record* should address the embedding of bolts in concrete if the bolts have coatings containing aluminum. The alkalinity of wet and freshly hardened concrete (less than 7 days old) reacts with free aluminum leading to evolution of hydrogen gas that consumes the aluminum and can lead to “wormholes” in the concrete. No research has been performed to date to determine if the aluminum bound within the coatings is susceptible to this reaction.

2.8.3. Galvanized or Coated Direct Tension Indicators

Direct tension indicators are permitted to be mechanically galvanized in accordance with ASTM B695 Class 55 or thermo-diffusion coated in accordance with ASTM A1059. Other coatings compatible with threaded components used in the work are permitted with the approval of the *DTI Manufacturer*.

Commentary:

ASTM F959 requires that coatings other than mechanically galvanized zinc and thermally diffused zinc shall be used only when approved by the *direct tension indicator Manufacturer*.

2.9. Test Reports

Test reports documenting conformance to the applicable specifications for all *bolting components* and *matched bolting assemblies* shall be available to the *Engineer of Record* and *Inspector* prior to assembly or erection of structural steel.

Commentary:

Test reports provided by the *Manufacturer* or *Supplier* of *bolting components* and *matched bolting assemblies* are required to verify that the components are identifiable and meet the requirements of the applicable ASTM standard or appropriate consensus standard.

2.10. Storage and Lubrication

- 2.10.1. Once received at the installation site, *bolting components* and *bolting assemblies* shall be kept in *protected storage*.
- 2.10.2. Only as many *bolting components* and *bolting assemblies* as are anticipated to be installed during the work shift shall be taken from *protected storage*.
- 2.10.3. *Bolting components* and *bolting assemblies* that are not incorporated into the work shall be returned to *protected storage* at the end of the work shift.
- 2.10.4. *Bolting components* (including some *bolting assemblies*) may be field lubricated to help with installation as deemed practical or necessary, except that the following *matched bolting assemblies* shall not be relubricated by anyone other than the *Manufacturer*:

- (1) *Spline end twist-off matched bolting assemblies*;
 - (2) *Matched bolting assemblies* when using the *combined method* and ASTM F3148 Grade 144 *spline end fixed matched bolting assemblies*; and
 - (3) *Alternative-design bolting components* or *matched bolting assemblies* (see Section 2.12).
- 2.10.5. Heavy hex head bolting components for *snug-tightened joints* that accumulate rust or dirt shall not be incorporated into the work unless they are cleaned and lubricated, if necessary.
- 2.10.6. *Bolting components* and *bolting assemblies* intended for *pretensioned* or *slip-critical joints* that accumulate rust or dirt shall not be incorporated into the work unless they are cleaned and lubricated, if necessary, and then retested as specified in Section 7. See Section 2.10.4 for prohibitions on relubrication.
- 2.10.7. *Temporary bolts* shall be exempt from this Section's storage requirements.

Commentary:

Protected storage requirements are specified for *high-strength bolts*, nuts, washers, and other *bolting components* so that the components' as-manufactured conditions are maintained as nearly as possible until they are incorporated in the work.

Because *Manufacturers* may apply various coatings and lubricants to prevent corrosion or to facilitate manufacture or installation, the condition of supplied *bolting components* and *bolting assemblies* should not be altered.

If *bolting components* or *bolting assemblies* become dirty, rusty, or otherwise have their as-received condition altered, they may be unsuitable for *pretensioned* installation. It is also possible that a *bolting assembly* may not pass the pre-installation verification requirements of Section 7. Some *components* can be cleaned and lubricated by the fabricator or the erector. Because the acceptability of their installation is dependent upon specific lubrication, the following may be lubricated only by the *Manufacturer*:

- (1) *Spline end twist-off matched bolting assemblies*,
- (2) *Spline end fixed matched bolting assemblies*,
- (3) Heavy hex *bolting assemblies* sold as *matched bolting assemblies* to be installed using the *combined method*, and
- (4) Some alternative-design bolts and *bolting assemblies* as specified in the relevant consensus standard.

2.11. Reuse

- 2.11.1. Plain finish Group 120 heavy hex bolts may be *reused* (1) in *snug-tightened joints* without *Engineer of Record* approval and (2) in *pretensioned joints* and *slip-critical joints* with *Engineer of Record* approval.
- 2.11.2. Galvanized or coated bolts of any Group or grade, galvanized or coated *spline end bolting assemblies* of any Group or grade, and Group 150 heavy hex bolts shall not be *reused*.

2.11.3. *Touching up* shall not be considered a *reuse*.

Commentary:

Pretensioned installation involves the inelastic elongation of the portion of the threaded length between the nut and the thread run-out. Plain finish ASTM F3125 Grade A325 and F1852 bolts possess sufficient ductility to undergo more than one *pretensioned* installation as suggested in the *Guide* (Kulak et al., 1987). As a simple rule of thumb, a plain finish Grade A325 bolt is suitable for *reuse* if the nut can be run all the way up the threads by hand.

On the other hand, while ASTM F3125 Grade A490 and F2280 bolts possess sufficient ductility to undergo one *pretensioned* installation, they are not consistently ductile enough to undergo a second pretensioned installation. The *Guide* also indicates that the coating on galvanized Grade A325 and F1852 bolts reduces their nut rotation capacity and are thus not to be *reused*. For additional guidance see Bowman and Betancourt (1991).

2.12. Alternative-Design Bolting Components, Assemblies, and Methods

The Specification allows for innovation in *bolting components* and *assemblies* in *joints* that transmit forces through shear, tension, combined tension and shear, or friction on *faying surfaces* and that meet the requirements in this Section. Other mechanical fasteners are not covered in this Specification. The provisions in this Specification that are not explicitly covered by the relevant consensus standard of an alternative-design *bolting component* or *assembly* shall still apply.

2.12.1. When approved by the *Engineer of Record*, alternative-design *bolting components*, *assemblies*, or installation methods are permitted to replace or supplement *bolting components*, *assemblies*, or installation methods described elsewhere in this Specification under the following conditions:

- (1) *Bolting components* or *assemblies* shall meet the minimum manufacturing, material, and mechanical properties of the grade and type being substituted;
- (2) When used in *pretensioned* or *slip-critical joints*, the alternative-design product or method must meet minimum *pretension* requirements set in Table 5.2 for the Group being substituted; and
- (3) When required by a product or consensus standard or the installation method, the alternative-design *bolting components* shall be supplied and used in the work as a *matched bolting assembly*.

2.12.2. When approved by the *Engineer of Record*, the use of consensus standards that are not referenced in Section 2 is permitted, under the following conditions:

- (1) Alternative design *bolting components* or *assemblies* must meet the minimum manufacturing, material, and mechanical properties of an approved consensus standard;

- (2) When considering strength levels other than those provided in this Specification, the consensus standard or *Manufacturer* shall provide, or the *Engineer of Record* shall determine, the minimum (and maximum, when applicable) specified values for at least:
 - a. Proof load and tensile strength;
 - b. *Nominal strength* values for Table 5.1;
 - c. Minimum *pretension* values for Table 5.2, as required;
 - d. Fatigue strength values for Table 5.3, as required.

In addition, the consensus standard or *Manufacturer* shall provide:

- e. Washer requirements, as required or if different than Section 6; and
 - f. Pre-installation verification test, installation, and inspection requirements, if applicable.
- (3) When required by a consensus standard or the installation method, the *bolting components* shall be supplied and used in the work as a *matched bolting assembly*.
- 2.12.3. Alternative coatings shall meet the performance criteria as specified in the alternative coating standard and shall not have a detrimental effect on the *bolting components* or *assemblies*, specifically in conformance to Sections 2.12.1(1) and (2).
- 2.12.4. Alternative-design *bolting components* or *assemblies* are permitted to differ in dimensions from those specified in Section 2 with the following limitations:
- (1) Bolts shall have a body diameter and bearing area under the head equal to or greater than that provided by an equivalent bolt in Section 2.7;
 - (2) Bolt thread lengths that differ from those in Section 2.7 shall be clearly identified and communicated to the *Engineer of Record*; and
 - (3) Nuts and washers shall have a bearing area that is equal to or greater than that provided by a nut or washer of the same nominal dimensions specified in Section 2.7, as applicable.
- 2.12.5. Installation methods shall be provided in the relevant consensus standard or by the *Manufacturer* and shall be approved by the *Engineer of Record*. These instructions shall provide, as a minimum:

- (1) For *pretensioned* and *slip-critical joints*, the procedure and frequency of pre-installation verification;
- (2) The alignment of bolt holes to permit insertion of the bolt without undue damage to the threads;
- (3) The placement of *bolting assemblies* in all types and sizes of holes, including placement and orientation of the alternative design devices (and ASTM F436/436M washers, if any);
- (4) The systematic assembly of the *joint* to the snug-tight condition, progressing from the most rigid part of the *joint* until the connected plies are in *firm contact*; and
- (5) For *pretensioned* and *slip-critical joints*, the subsequent systematic *pretensioning* of all bolting assemblies in the *joint*, progressing from the most rigid part of the *joint* in a manner that will minimize relaxation of previously *pretensioned* bolts.

- 2.12.6. Inspection instructions shall be provided in the relevant consensus standard or by the *Manufacturer* and shall be approved by the *Engineer of Record*. These instructions shall provide, as a minimum:
- (1) Required observation of the pre-installation verification testing, when performed; and
 - (2) Subsequent *routine observation* to verify the proper use of the alternative-design product or method.

Commentary:

RCSC's policy has been to recognize only *bolting components* and *matched bolting assemblies* that meet approved ASTM standards. Other consensus standards that could be considered by the *Engineer of Record* include EN, JIS, and ISO standards. However, alternate products, standards, and installation methods (known collectively as "alternative-designs") may be used when approved by the *Engineer of Record*. Alternative-designs fall into two categories:

- (1) Product made as an alternative-design to an ASTM standard referenced in this document and installed using RCSC installation methods or an alternate installation method. See Section 2.12.1.
- (2) Product made to an ASTM standard that is *not* referenced in this document or made to another consensus standard and installed using RCSC installation methods or an alternate installation method. See Section 2.12.2.

When using alternative-designs it is important that the strength of the component and geometry be fully considered so that the requirements of *joint* design are met as intended by this Specification. Particularly important are strength requirements, such as tensile strength, shear strength, and minimum *pretension*, along with certain dimensional characteristics vital to proper *joint* loading, such as bearing area and bolt body diameter.

Alternative-design provisions are intended to provide flexibility to address unique needs and design challenges and to enable the use of alternate technology, standards, and practices. This includes products or technology the Council may not have had the time or opportunity to fully consider, or products with a frequency of use that might not compel the Council to detail such use in this document.

SECTION 3. BOLTED PARTS

3.1. Connected Plies

Unless otherwise approved by the *Engineer of Record*, all connected plies in a *joint* that are within the *grip* of the bolt and any materials that are used under the bolt head or nut shall be steel with *faying surfaces* that are *uncoated*, *coated*, or *galvanized* as defined in Section 3.2.

The slope of the surfaces of parts in contact with the bolt head and nut shall be equal to or less than 1:20 with respect to a plane that is normal to the bolt axis.

Commentary:

The presence of gaskets, insulation, or any compressible materials other than the specified coatings within the *grip* will preclude the development and/or retention of the installed *pretensions* in the bolts, when required. See the Commentary to Section 1.1.

Structural bolting assemblies are generally ductile enough to deform to a surface with a slope that is less than or equal to 1:20 with respect to a plane normal to the bolt axis when *pretensioned*. Greater slopes are undesirable because the resultant localized bending decreases both the strength and the ductility of the bolt.

3.2. Faying Surfaces

Faying surfaces and surfaces adjacent to the bolt head and nut shall be free of dirt and other foreign material.

- 3.2.1. *Snug-Tightened Joints* and *Pretensioned Joints*: The *faying surfaces* of *snug-tightened joints* and *pretensioned joints* as defined in Sections 4.1 and 4.2 are permitted to be *uncoated*, *coated* with coatings of any formulation, or *galvanized*.

Commentary:

In both *snug-tightened joints* and *pretensioned joints*, the ultimate strength is dependent upon shear transmitted by the bolts and bearing of the bolts against the connected material. It is independent of any frictional resistance that may exist on the *faying surfaces*. Consequently, since slip resistance is not an issue, the *faying surfaces* are permitted to be *uncoated*, *coated*, or *galvanized* without regard to the resulting slip coefficient obtained.

For *pretensioned joints*, caution should be used in the specification and application of thick coatings within the *faying surface*, and on ply surfaces under the bolt head, and under the nut or washer. Although slip resistance is not required, *bolting assemblies* in *joints* with thick or multi-layer coatings may exhibit significant loss of *pretension* because of compressive creep in softer coatings such as epoxies, alkyds, vinyls, acrylics, and urethanes. Previous bolt relaxation studies have been conducted using uncoated steel with plain finish bolts or galvanized steel with galvanized bolts. *Galvanized faying surfaces* ranged up to approximately 4 mils of thickness, of which approximately half the thickness

was the compressible soft pure zinc surface layer. The underlying zinc-iron layers are very hard and would exhibit little creep. See *Guide*, Section 4.4. Tests have indicated that significant bolt *pretension* may be lost when the total coating thickness within the *joint* approaches 15 mils per surface and that soft surface coatings beneath the bolt head and nut can contribute to additional reduction in *pretension*.

3.2.2. *Slip-Critical Joints*: The *faying surfaces* of *slip-critical joints*, including those of filler plates and finger shims, shall meet the following requirements:

- (1) *Uncoated Faying Surfaces*: *Uncoated faying surfaces* (a) shall be free of scale (except tight mill scale), coatings, and overspray (i) in areas closer than one bolt diameter but not less than 1 in. from the edge of any hole, and (ii) in all areas within the bolt pattern, or (b) shall be blast cleaned prior to assembly.
- (2) *Coated Faying Surfaces*: *Coated faying surfaces* shall first be blast cleaned and subsequently coated with a coating that is qualified in accordance with Appendix A as a Class A or Class B coating (as defined in Section 5.4). Alternatively, when approved by the *Engineer of Record*, coatings that provide a *mean slip coefficient* that differs from Class A or Class B are permitted when:
 - (i) The *mean slip coefficient* μ is established by testing in accordance with the requirements in Appendix A; and
 - (ii) The design slip resistance is determined in accordance with Section 5.4 using this coefficient, except that, for design purposes, a value of μ greater than 0.50 shall not be used.

The plies of *slip-critical joints* with *coated faying surfaces* shall not be assembled before the coating has fully *cured* and in no case before the minimum time that was used in the qualifying tests or provided in the coating manufacturer's application instructions.

On members coated with non-qualified coatings, the *faying surfaces* shall be free of coating and overspray (1) in areas closer than one bolt diameter but not less than 1 in. from the edge of any hole, and (2) in all areas within the bolt pattern. See Figure C-3.1.

- (3) *Galvanized Faying Surfaces*: *Galvanized faying surfaces* shall be hot-dip galvanized in accordance with the requirements of ASTM A123. Power or hand wire brushing is not permitted. *Galvanized faying surfaces* are designated as Class A for design.

Commentary:

Slip-critical joints are those *joints* that have specified *faying surface* conditions that, in the presence of the clamping force provided by *pretensioned bolting assemblies*, resist a design load solely by friction and without displacement at the *faying surfaces*. Consequently, it is necessary to prepare the *faying surfaces* in a manner such that the desired slip performance is achieved.

Clean mill scale steel surfaces (Class A, see Section 5.4) and blast-cleaned steel surfaces (Class B, see Section 5.4) can be used within *slip-critical joints*. When used, it is necessary to keep the *faying surfaces* free of coatings, including inadvertent overspray.

Corrosion often occurs on uncoated blast-cleaned steel *faying surfaces* (Class B, see Section 5.4) due to exposure between the time of fabrication and subsequent erection. In normal atmospheric exposures, this corrosion is not detrimental and may actually increase the slip resistance of the *joint*. Yura et al. (1981) found that the Class B slip coefficient could be maintained for up to one year prior to *joint* assembly.

Polyzois and Frank (1986) demonstrated that, for plate material with thickness in the range of $\frac{3}{8}$ in. to $\frac{3}{4}$ in., the contact pressure caused by bolt *pretension* is concentrated on the *faying surfaces* in annular rings around and close to the bolts. In this study, unqualified paint on the *faying surfaces* away from the edge of the bolt hole by at least one bolt diameter but not less than 1 in. did not reduce the slip resistance. However, this would not likely be the case for *joints* involving thicker material, particularly those with a large number of bolts on multiple gage lines; the minimum bolt *pretension* in Table 5.2 might not be adequate to completely flatten and pull thicker material into tight contact around every bolt. Instead, the bolt *pretension* would be balanced by contact pressure on the regions of the *faying surfaces* that are in contact. To account for both possibilities, it is required in this Specification that for unqualified coatings all areas between the bolts be free of coatings, including overspray, as illustrated in Figure C-3.1.

As a practical matter, the smaller coating-free area can be laid out and protected more easily using masking located relative to the bolt-hole pattern than relative to the limits of the complete area of *faying surface* contact with varying and uncertain edge distance. Furthermore, the narrow coating strip around the perimeter of the *faying surface* minimizes the required field touch-up of uncoated material outside of the *joint*.

Polyzois and Frank (1986) also investigated the effect of various degrees of inadvertent overspray on slip resistance. It was found that even a small amount of overspray of unqualified paint (that is, not qualified as a Class A or Class B coating) within the specified coating-free area on clean mill scale can reduce the slip resistance significantly. On blast-cleaned surfaces, however, the presence of a small amount of overspray was not as detrimental. For simplicity, this Specification requires that all overspray be prohibited from areas that are required to be free of coatings in *slip-critical joints* regardless of whether the surface is clean mill scale steel or blast-cleaned steel.

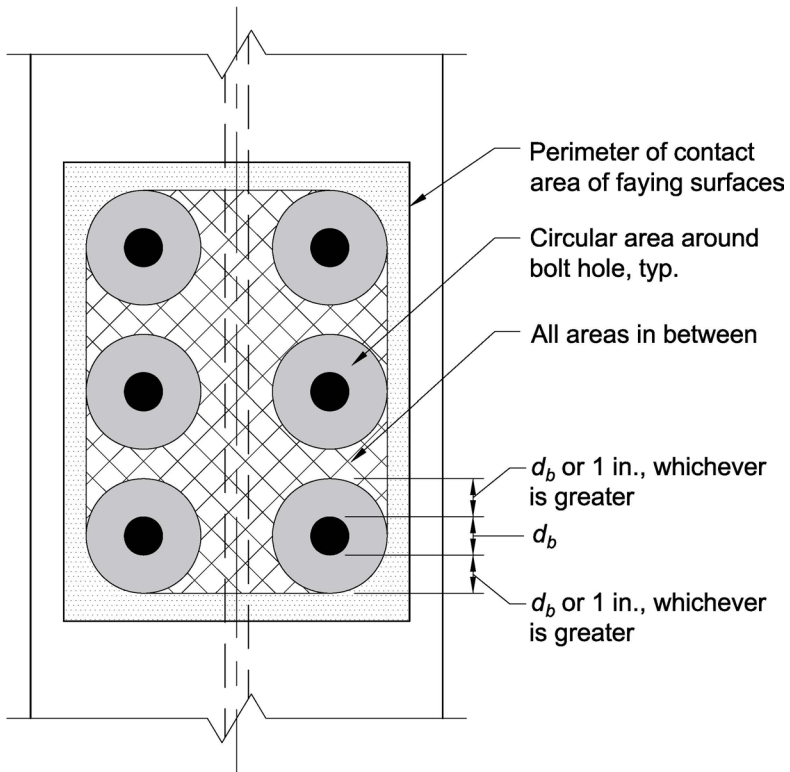

Figure C-3.1. Areas of faying surfaces of slip-critical joints to remain uncoated with unqualified coatings (d_b = bolt diameter).

When the *faying surfaces* of a *slip-critical joint* are to be protected against corrosion, a qualified coating must be used. A qualified coating is one that has been tested in accordance with Appendix A, the sole basis for qualification of any coating to be used in conjunction with this Specification. Coatings can be qualified as follows:

- (1) As a Class A coating as defined in Section 5.4;
- (2) As a Class B coating as defined in Section 5.4; or
- (3) As a coating with a *mean slip coefficient* μ of at least 0.30 (Class A) but not greater than 0.50 (Class B).

Retesting is required if any essential variable associated with *cure*, coating composition, or method of manufacture is changed. See Appendix A.

For *slip-critical joints*, coating testing as prescribed in Appendix A includes creep tests, which incorporate relaxation in the *bolting assembly* and the effect of the coating itself. Specifiers should verify the coating thicknesses used in the Appendix A testing and verify that the actual maximum average coating thickness is at least 2 mm less than the coating thickness tested. See Appendix A and Section A1.2.2.

Frank and Yura (1981) also investigated the effect of varying the time between coating the *faying surfaces* and assembly of the *joint* and *pretensioning* the bolts in order to ascertain if partially cured paint continued to *cure* within the assembled *joint* over a period of time. The results indicated that all curing effectively ceased at the time the *joint* was assembled and paint that was not fully cured at that time acted as a lubricant. The slip resistance of a *joint* that was assembled after a time less than the curing time used in the qualifying tests was severely reduced. Thus, the *degree of cure* prior to mating the *faying surfaces* is an essential parameter to be specified and controlled during construction.

Prior versions of this Specification included a requirement to hand wire-brush galvanized surfaces in *slip-critical joints*, but recent research in combination with current galvanizing practices has revealed that such brushing does not improve slip resistance capacity and may reduce it (Donahue et al., 2014).

Field experience and test results have indicated that galvanized assemblies may continue to slip under sustained loading (Kulak et al., 1987). Tests of hot-dip galvanized *joints* subjected to sustained loading show a creep-type behavior that was not observed in short-duration or fatigue-type load application. See Appendix A and Commentary to A4.2.

3.3. Bolt Holes

The nominal dimensions of standard, oversized, short-slotted, and long-slotted holes for *high-strength bolts* shall be equal to or less than those shown in Table 3.1. Holes detailed larger than those shown in Table 3.1 are permitted when specified or approved by the *Engineer of Record*. When complete *connection* design is not shown in the structural design drawings, the *Engineer of Record* shall be notified of the type and dimensions of holes to be used. Oversized holes, short slots not perpendicular to the applied load, and long slots in any direction shall be subject to approval by the *Engineer of Record*. Any restrictions on the use of hole types permitted in this section shall be specified in the design documents.

Thermally cut holes produced by mechanically guided means are permitted in statically loaded *joints*. The surface roughness profile of the hole shall not exceed 1,000 microinches as defined in ASME B46.1. Occasional gouges not more than $\frac{1}{16}$ in. in depth are permitted. Thermally cut holes produced free hand shall be permitted in statically loaded *joints* upon approval by the *Engineer of Record*.

For cyclically loaded *slip-critical joints*, mechanically guided thermally cut holes shall be permitted. For other cyclically loaded *joints*, thermally cut holes shall be permitted upon approval by the *Engineer of Record*.

Table 3.1
Nominal Bolt Hole Dimensions

Nominal Bolt Diameter, d_b , in.	Nominal Bolt Hole Dimensions ^{a,b} , in.			
	Standard (diameter)	Oversized (diameter)	Short-Slotted (width × length)	Long-Slotted (width × length)
1/2	9/16	5/8	9/16 × 1 1/16	9/16 × 1 1/4
5/8	1 1/16	13/16	1 1/16 × 7/8	1 1/16 × 1 9/16
3/4	13/16	15/16	13/16 × 1	13/16 × 1 7/8
7/8	15/16	1 1/16	15/16 × 1 1/8	15/16 × 2 3/16
1	1 1/8	1 1/4	1 1/8 × 1 5/16	1 1/8 × 2 1/2
≥ 1 1/8	$d_b + 1/8$	$d_b + 5/16$	$(d_b + 1/8) × (d_b + 3/8)$	$(d_b + 1/8) × (2.5d_b)$

^a The detailed hole dimension shall not exceed the nominal. The fabricated hole dimension shall not exceed the nominal +1/32 in. Exception: In the width of slotted holes, gouges not more than 1/16 in. deep are permitted.

^b The slightly conical hole that naturally results from punching operations with properly matched punches and dies is acceptable.

Commentary:

The footnotes in Table 3.1 provide for slight variations in the dimensions of bolt holes from the nominal dimensions. When the dimensions of bolt holes are such that they exceed these permitted variations, the bolt hole must be treated as the next larger type.

Slots longer than standard long slots may be required to accommodate construction tolerances or expansion joints. Larger oversized holes may be necessary to accommodate construction tolerances or misalignments. In these two cases, the Specification provides no guidance for further reduction of *design strengths* or allowable loads. At a minimum, engineering design considerations in these cases should include the effects of edge distance, net section, reduction in clamping force (in *slip-critical joints*), washer requirements, bearing capacity, and hole deformation.

For thermally cut holes produced free hand, it is usually necessary to grind the hole's interior surface after thermal cutting in order to achieve a maximum surface roughness profile of 1,000 microinches.

Slotted holes in statically loaded *joints* are often produced by punching or drilling the hole ends and thermally cutting the sides of the slots by mechanically guided means. The sides of such slots should be ground smooth, particularly at the junctures of the thermal cuts to the hole ends.

For cyclically loaded *joints*, test results have indicated that when no major slip occurs in the *joint*, fretting fatigue failure usually occurs in the gross section prior to fatigue failure in the net section (Kulak et al., 1987). Conversely, when slip occurs in the *joints* of cyclically loaded *connections*, failure usually occurs in the net section and the edge of a bolt hole becomes the point of crack initiation (Kulak et al., 1987). Therefore, for cyclically loaded *joints* designed as slip-critical, the method used to produce bolt holes (either thermal cutting or drilling) should not influence the ultimate failure load, as failure usually occurs in the gross section when no major slip occurs.

3.3.1. Standard Holes: Standard holes are permitted to be used in all plies of bolted *joints*.

Commentary:

The use of bolt holes $\frac{1}{16}$ in. larger than the bolt installed in them has been permitted since the first publication of this Specification. The increase in bolt hole diameter in this edition for standard holes and the width of short and long slotted holes is to facilitate entry of larger diameter bolts into holes. For bolts of $1\frac{3}{8}$ -in. and $1\frac{1}{2}$ -in. diameter, the permitted tolerance for swell or fin under the head or any die seam on the body exceeds the previous hole clearance of $\frac{1}{16}$ in. For bolts of $\frac{3}{4}$ -in. through $1\frac{1}{4}$ -in. diameter, these tolerances would allow only 0.02-in. clearance. Smaller diameter bolts are commonly cold-formed with little swell, fins, or seams. Larger bolt diameters are commonly hot-forged where these issues are more common. Based upon typical production and use, the hole diameter and slot width clearance were increased to $\frac{1}{8}$ in. for bolts 1-in. diameter and greater, and clearances for smaller bolts remained unchanged. The increase is also intended to reduce the need for reaming during *joint* assembly and the use of oversized holes for large diameter bolts that requires *joints* to be designed as *slip-critical joints*, as well as to bring bolt hole diameters into closer alignment with other major international steel construction standards. The change was supported by research by Allan (1967), Allan and Fisher (1968), Fisher and Beedle (1964), Chesson et al. (1964), Hoyer (1960), and Borello (2009). Allan and Fisher (1968) showed that even larger holes could be permitted for *high-strength bolts* without adversely affecting the bolt shear or member bearing strength. However, the slip resistance can be reduced by the failure to achieve adequate *pretension* initially or by the relaxation of the bolt *pretension* as the highly compressed material yields at the edge of the hole or slot.

3.3.2. Oversized Holes

3.3.2.1. For *snug-tightened* or *pretensioned joints* subject to shear or combined shear and tension, oversized holes are not permitted. In such *joints* subject to tension only, oversized holes are permitted upon approval by the *Engineer of Record*.

3.3.2.2. For *slip-critical joints*, oversized holes are permitted in any or all plies upon approval by the *Engineer of Record*.

Commentary:

The provisions for oversized holes in this Specification are based upon the findings of Allan and Fisher (1968) and the additional concern for the consequences of a slip of significant magnitude that can occur as permitted by the oversized hole.

3.3.3. Short-Slotted Holes

- 3.3.3.1. For *snug-tightened* or *pretensioned joints*, short-slotted holes are permitted in only one ply at any individual *faying surface* of any *joint*, provided the applied load is approximately perpendicular (between 80 and 100 degrees) to the axis of the slot. When complete *connection* design is not shown in the structural design drawings, the *Engineer of Record* shall be notified when short-slotted holes are used in this manner.
- 3.3.3.2. For *snug-tightened* or *pretensioned joints*, upon approval by the *Engineer of Record*, short-slotted holes are permitted in more than one or all plies, provided the applied load is approximately perpendicular (between 80 and 100 degrees) to the axis of the slot(s).
- 3.3.3.3. For *slip-critical joints*, upon approval by the *Engineer of Record*, short-slotted holes are permitted in any or all plies without regard for the direction of the applied load.

Commentary:

For beam end *connections*, the use of short-slotted holes approximately perpendicular to the applied load in conjunction with snug-tight bolts can provide the shear capacity and may allow the beam to rotate consistently with the design assumptions. Deformation of *connections* can be a concern where the beam is not laterally or torsionally restrained by floor, roof, or other framing.

Short slots are used to account for minor adjustments in main members such as web thickness differences and member length. This practice is prevalent enough that this Specification permits it unless it is specifically prohibited by the *Engineer of Record* in the design documents. This specification requires the *Engineer of Record* to be notified of the hole types and dimensions by showing this information on shop detail drawings or by obtaining prior approval of the *Engineer of Record*.

The provision limiting the use of short slotted holes to one ply with snug-tight bolts is to avoid the use of short slotted holes in opposing plies of a *faying surface*. The use of short slotted holes with snug-tight bolts in *connections* with multiple plies that do not share a *faying surface* is still permitted. An example that would be permitted with multiple plies includes beam end *connections* on opposing sides of a column web.

3.3.4. Long-Slotted Holes:

- 3.3.4.1. For *snug-tightened* or *pretensioned joints*, upon approval by the *Engineer of Record*, long-slotted holes are permitted in only one ply at any individual *faying surface*, provided the applied load is approximately perpendicular (between 80 and 100 degrees) to the axis of the slot.
- 3.3.4.2. For *slip-critical joints*, upon approval by the *Engineer of Record*, long-slotted holes are permitted in only one ply at any individual *faying surface*, without regard for the direction of the applied load.
- 3.3.4.3. Fully inserted finger shims between the *faying surfaces* of load-transmitting elements of bolted *joints* are not considered a long-slotted element of a *joint*, nor are they considered to be a ply at any individual *faying surface*. However, for *slip-critical joints*, finger shims shall have the same *surface preparation* as the plies.

Commentary:

See the Commentary to Section 3.3.1. Finger shims are devices that are often used to permit the alignment and plumbing of structures. When these devices are fully and properly inserted, they do not have the same effect on bolt *pretension* relaxation or the *connection* performance as do long-slotted holes in an outer ply. When fully inserted, the shim provides support around approximately 75 percent of the perimeter of the bolt in contrast to the greatly reduced area that exists with a bolt that is centered in a long slot. Furthermore, finger shims are always enclosed on both sides by the connected material, which should be effective in bridging the space between the fingers.

3.4. Burrs

Burrs less than or equal to $\frac{1}{16}$ in. in height are permitted to remain on *faying surfaces* of all *joints*. Burrs larger than $\frac{1}{16}$ in. in height shall be removed or reduced to $\frac{1}{16}$ in. or less from the *faying surfaces* of all *joints*.

Commentary:

Polyzois and Yura (1985) and McKinney and Zwerneman (1993) demonstrated that the slip resistance of *joints* was either unchanged or slightly improved by the presence of burrs. Therefore, small ($\frac{1}{16}$ in. or less in height) burrs need not be removed. On the other hand, parallel tests in the same program demonstrated that large burrs (over $\frac{1}{16}$ in. in height) could cause a small increase in the required nut rotation from the *snug-tight condition* to achieve the specified *pretension* with the *turn-of-nut method*. Therefore, the Specification requires that all large burrs be removed or reduced in height.

Note that prior to *pretensioning*, the snug-tightening procedure is required to bring the plies into *firm contact*. If *firm contact* has not been achieved after snugging due to the presence of burrs, additional snugging is required to flatten them and bring the plies into *firm contact*.

SECTION 4. JOINT TYPE

For *joints* with bolts that are loaded in shear or combined shear and tension, the *Engineer of Record* shall specify the *joint* type in the contract documents as *snug-tightened*, *pretensioned*, or *slip-critical*. For *slip-critical joints*, the required class of slip resistance in accordance with Section 5.4 shall also be specified. For *joints* with bolts that are loaded in tension only, the *Engineer of Record* shall specify the *joint* type in the contract documents as *snug-tightened* or *pretensioned*. Table 4.1 summarizes the applications and requirements of the three *joint* types.

Table 4.1
Summary of Applications and Requirements for Bolted Joints

Load Transfer	Application	Joint Type ^{a,b}	Faying Surface Prep.	Install per Section	Inspect per Section	Arbitrate per Section 10
Shear only	Resistance to shear load by shear/bearing.	ST	No	8.1	9.1	No
	Resistance to shear load by shear/bearing. Bolt <i>pretension</i> is required, but for reasons other than slip resistance.	PT	No	8.2	9.2	If req'd to resolve dispute
	Resistance to shear load by friction on <i>faying surfaces</i> is required.	SC	3.2.2	8.2	9.3	If req'd to resolve dispute
Combined shear and tension	Resistance to shear load by shear/bearing. Tension load is static only. ^c	ST	No	8.1	9.1	No
	Resistance to shear by shear/bearing. Bolt <i>pretension</i> is required, but for reasons other than slip resistance.	PT	No	8.2	9.2	If req'd to resolve dispute
	Resistance to shear load by friction on <i>faying surfaces</i> is required.	SC	3.2.2	8.2	9.3	If req'd to resolve dispute
Tension only	Static loading only. ^c	ST	No	8.1	9.1	No
	All other conditions of tension-only loading.	PT	No	8.2	9.2	If req'd to resolve dispute

^a Under *Joint* Type: ST = *snug-tightened*, PT = *pretensioned*, and SC = *slip-critical*; see Section 4.
^b See Sections 4 and 5 for the design requirements for each *joint* type.
^c Per Section 4.2, the use of Group 144 and 150 bolts in *snug-tightened joints* with tensile loads is not permitted.

Commentary:

When first approved by the Research Council on Structural Connections in January 1951, the “Specification for Assembly of Structural Joints Using High-Strength Bolts” merely permitted the substitution of a like number of ASTM A325 bolts for hot-driven ASTM A141¹ steel rivets of the same nominal diameter. Additionally, it was required that all bolts be *pretensioned* and that all *faying surfaces* be free of paint; hence, satisfying the requirements for a *slip-critical joint* by the present-day definition. As revised in 1954, the omission of paint was required to apply only to “*joints* subject to stress reversal, impact or vibration, or to cases where stress redistribution due to *joint* slippage would be undesirable.” This relaxation of the earlier provision recognized the fact that, in many applications, movement of the connected parts that brings the bolts into bearing against the sides of their holes is in no way detrimental. Bolted *joints* were then designated as “bearing type,” “friction type,” or “direct tension.” With the 1985 edition of this Specification, these designations were changed to “shear/bearing,” “slip-critical,” and “direct tension,” respectively, and snug-tightened installation was permitted for many *shear/bearing joints*. *Snug-tightened joints* are also permitted for qualified applications involving Group 120 bolts in direct tension. It is important that the snug-tightened *bolting assemblies* are tightened uniformly to ensure that all *bolting assemblies* participate equally in carrying the load to match the design assumption.

If non-*pretensioned* bolts are used in the type of *joint* that places the bolts in shear, load is transferred by shear in the bolts and bearing stress in the connected material. At the ultimate limit state, failure will occur by shear failure of the bolts, by bearing failure of the connected material, or by failure of the member itself. On the other hand, if *pretensioned* bolts are used in such a *joint*, the frictional force that develops between the connected plies will initially transfer the load. Until the frictional force is exceeded, there is no shear in the bolts and no bearing stress in the connected components. A further increase of load places the bolts into shear and against the connected material in bearing, just as was the case when non-*pretensioned* bolts were used. Since it is known that the *pretension* in bolts will have been dissipated by the time bolt shear failure takes place (Kulak et al., 1987), the ultimate limit state of a *pretensioned* bolted *joint* is the same as an otherwise identical *joint* that uses non-*pretensioned* bolts.

Because the consequences of slip into bearing vary from application to application, the determination of whether a *joint* can be designated as *snug-tightened* or as *pretensioned*, or rather must be designated as *slip-critical*, is best left to judgment and a decision on the part of the *Engineer of Record*. In the case of *joints* with three or more bolts in holes with only a small clearance, the freedom to slip generally does not exist. It is probable that normal fabrication tolerances and erection procedures are such that one or more bolts are in bearing even before additional load is applied. Such is the case for standard holes and for slotted holes loaded transversally to the axis of the slot.

¹ ASTM A141 (discontinued in 1967) became identified as ASTM A502 Grade 1.

Joints that are required to be *slip-critical joints* include:

- (1) Those cases where slip movement could theoretically exceed an amount deemed by the *Engineer of Record* to affect the serviceability of the structure, or through excessive distortion cause a reduction in strength or stability, even though the resistance to fracture of the *connection* and yielding of the member may be adequate; and
- (2) Those cases where slip of any magnitude must be prevented, such as in *joints* subject to significant load reversal and *joints* between elements of built-up compression members in which any slip could cause a reduction of the flexural stiffness, which is required for the stability of the built-up member.

In this Specification, the provisions for the design, installation, and inspection of bolted *joints* are dependent upon the type of *joint* that is specified by the *Engineer of Record*. Consequently, it is required that the *Engineer of Record* identify the *joint* type in the contract documents.

4.1. Snug-Tightened Joints

Except as required in Sections 4.2 and 4.3, *snug-tightened joints* are permitted.

Bolts in *snug-tightened joints* shall be designed in accordance with the applicable provisions of Sections 5.1, 5.2 and 5.3, installed in accordance with Section 8.1, and inspected in accordance with Section 9.1. As indicated in Table 4.1, requirements for *faying surface* condition shall not apply to *snug-tightened joints*.

Commentary:

Recognizing that the ultimate strength of a *connection* is independent of the bolt *pretension* and slip movement, there are numerous practical cases in the design of structures where, if slip occurs, it will not be detrimental to the serviceability of the structure. Additionally, there are cases where slip of the *joint* is desirable to permit rotation in a *joint* or to minimize the transfer of moment. To provide for these cases while at the same time making use of the shear strength of *high-strength bolts*, *snug-tightened joints* are permitted.

The maximum amount of slip that can occur in a *joint* is, theoretically, equal to twice the hole clearance. In practical terms, it is observed in laboratory and field experience to be much less; usually, about one-half the hole clearance. Acceptable inaccuracies in the location of holes within a pattern of bolts usually cause one or more bolts to be in bearing in the initial, unloaded condition. Furthermore, even with perfectly positioned holes, the usual method of erection causes the weight of the connected elements to put some of the bolts into direct bearing at the time the member is supported on loose bolts and the lifting crane is unhooked. Additional loading in the same direction would not cause additional *joint* slip of any significance.

4.2. Pretensioned Joints

Pretensioned joints are required in the following applications:

- (1) *Joints* in which bolt *pretension* is required in the specification or code that invokes this Specification;
- (2) *Joints* that are subject to significant load reversal;
- (3) *Joints* that are subject to fatigue load with no reversal of the loading direction;
- (4) *Joints* with Group 120 *bolting assemblies* that are subject to tensile fatigue; and
- (5) *Joints* with Group 144 or Group 150 *bolting assemblies* that are subject to tension or combined shear and tension, with or without fatigue.

Bolts in *pretensioned joints* subject to shear shall be designed in accordance with the applicable provisions of Sections 5.1 and 5.3, installed in accordance with Section 8.2, and inspected in accordance with Section 9.2. Bolts in *pretensioned joints* subject to tension or combined shear and tension shall be designed in accordance with the applicable provisions of Sections 5.1, 5.2, 5.3, and 5.5; installed in accordance with Section 8.2; and inspected in accordance with Section 9.2. As indicated in Table 4.1, requirements for *faying surface* condition shall not apply to *pretensioned joints*.

Commentary:

Certain shear *connections* had previously been listed in other specifications that were required to be *pretensioned* but were not required to be *slip-critical joints*, regardless of whether the potential for slip was a concern (AISC, 2010). Those *connections* included:

- (1) Column splices in buildings with high ratios of height to width;
- (2) *Connections* of members that provide bracing to columns in tall buildings;
- (3) Various *connections* in buildings with cranes over 5-ton capacity; and
- (4) *Connections* for supports of running machinery and other sources of impact or stress reversal.

When *pretension* is desired for reasons other than the necessity to prevent slip, a *pretensioned joint* should be specified in the contract documents.

4.3. Slip-Critical Joints

Slip-critical joints are required in the following applications involving shear or combined shear and tension:

- (1) *Joints* that are subject to fatigue load with reversal of the loading direction;
- (2) *Joints* that utilize oversized holes;
- (3) *Joints* that utilize slotted holes, except those with applied load approximately normal (within 80 to 100 degrees) to the direction of the long dimension of the slot; and
- (4) *Joints* in which slip at the *faying surfaces* would be detrimental to the performance of the structure.

Bolts in *slip-critical joints* shall be designed in accordance with the applicable provisions of Sections 5.1, 5.2, 5.3, 5.4, and 5.5; installed in accordance with Section 8.2; and inspected in accordance with Section 9.3.

Commentary:

In certain cases, slip of a bolted *joint* in shear under service loads would be undesirable or must be precluded. Clearly, *joints* that are subject to reversed fatigue load must be *slip-critical joints* since slip may result in back-and-forth movement of the *joint* and have potential for accelerated fatigue failure. Unless slip is intended, as desired in a sliding expansion *joint*, slip in *joints* with long-slotted holes that are parallel to the direction of the applied load might be large enough to invalidate structural analyses that are based upon the assumption of small displacements.

For *joints* subject to fatigue load with respect to shear of the bolts that do not involve a reversal of load direction, there are two alternatives for fatigue design. The designer can provide either a *slip-critical joint* that is proportioned on the basis of the applied stress range on the gross section or a *pretensioned joint* that is proportioned on the basis of the applied stress range on the net section.

SECTION 5. LIMIT STATES IN BOLTED JOINTS

The available shear strength and available tensile strength of bolts shall be determined in accordance with Section 5.1. The interaction of combined shear and tension on bolts shall be limited in accordance with Section 5.2. The available bearing strength of the connected parts at bolt holes shall be determined in accordance with Section 5.3. Each of these *available strengths* shall be equal to or greater than the *required strength*. The axial load in bolts that are subject to tension or combined shear and tension shall be calculated with consideration of the effects of the externally applied tensile load and any additional tension resulting from *prying action* produced by deformation of the connected parts.

When slip resistance is required at the *faying surfaces* subject to shear or combined shear and tension, slip resistance shall be checked at either the *LFRD-load* level or *ASD-load* level, at the option of the *Engineer of Record*. When slip of the *joint* under applied loads would affect the ability of the structure to support the loads, the *available strength* determined in accordance with Section 5.4 shall be equal to or greater than the *required strength*. In addition, *slip-critical joints* shall meet the strength requirements of *shear/bearing joints*. Therefore, the strength requirements of Sections 5.1, 5.2, and 5.3 shall also be met.

When bolts are subject to cyclic application of axial tension, the stress determined in accordance with Section 5.5 shall be equal to or greater than the stress due to the effect of the service loads, including any additional tension resulting from *prying action* produced by deformation of the connected parts.

Commentary:

This section of the Specification provides the design requirements for *high-strength bolts* in bolted *joints*. However, this information is not intended to provide comprehensive coverage of the design of *high-strength bolted connections*. Other design considerations of importance to the satisfactory performance of the connected material—such as block shear rupture, shear lag, *prying action*, and *connection* stiffness and its effect on the performance of the structure are beyond the scope of this Specification and Commentary.

The design of bolted *joints* that transmit shear requires consideration of the shear strength of the bolts and the bearing strength of the connected material. If such *joints* are designated as *slip-critical joints*, the slip resistance must also be checked.

Parameters that influence the shear strength of bolted *joints* include:

- (1) Geometric parameters—the ratio of the net area to the gross area of the connected parts, the ratio of the net area of the connected parts to the total shear-resisting area of the bolts, and the length of the *joint*; and
- (2) Material parameter—the ratio of the yield strength to the tensile strength of the connected parts.

Using both mathematical models and physical testing, it was possible to study the influences of these parameters (Kulak et al., 1987). These showed that, under the rules that existed at that time, the longest (and often the most important) *joints* had the lowest factor of safety, about 2.0 based on ultimate strength.

In general, bolted *joints* that are designed in accordance with the provisions of this Specification will have a higher reliability than the members they connect. This occurs primarily because the resistance factors used in limit states for the design of bolted *joints* were chosen to provide a reliability higher than that used for member design. Additionally, the controlling strength limit state in the structural member, such as yielding or deflection, is usually reached well before the strength limit state in the *connection*, such as bolt shear strength or bearing strength of the connected material. The installation requirements vary with *joint* type and influence the behavior of the *joints* within the service-load range; however, this influence is ignored in all strength calculations. Secondary tensile stresses that may be produced in bolts in *shear/bearing joints*, such as through the flexing of double-angle *connections* to accommodate the simple-beam end rotation, need not be considered.

It is sometimes necessary to use *high-strength bolts* and fillet welds in the same *connection*, particularly as the result of remedial work. When these fastening elements act in the same shear plane, it is recommended to make reference to the *Guide* or AISC 360 Section J1.8 for guidance.

5.1. Nominal Shear and Tensile Strengths

Shear and tensile strengths shall not be reduced by the installed bolt *pretension*. For *joints*, the nominal shear and tensile strengths shall be taken as the sum of the strengths of the individual bolts.

The *design strength* in shear or tension for a Group 120, 144, or 150 bolt is ϕR_n , where $\phi = 0.75$ and the *allowable strength* in shear or tension is R_n/Ω , where $\Omega = 2.00$ and:

$$R_n = F_n A_b \quad (\text{Equation 5.1})$$

where

R_n = *nominal strength* (shear strength per shear plane or tensile strength) of a bolt, kips

F_n = *nominal strength* per unit area from Table 5.1 for the appropriate applied load conditions, ksi, adjusted for the presence of fillers as required below

A_b = cross-sectional area based upon the nominal diameter of bolt, in.²

Bolts with lengths indicated in Table 2.5 are considered to be fully threaded in accordance with ASME B18.2.6. The shear strength of these bolts shall be determined based on the assumption that the threads are included in the shear plane.

When a bolt that carries load passes through fillers or shims in a shear plane that are equal to or less than 1/4 in. thick, F_n from Table 5.1 shall be used without reduction. When a bolt that carries load passes through fillers or shims that are greater than 1/4 in. thick, the *connection* shall be designed in accordance with one of the following procedures:

- (1) F_n from Table 5.1 shall be multiplied by the factor $[1 - 0.4(t' - 0.25)]$, which shall not be taken as greater than 1.00 nor smaller than 0.85, where t' is the total thickness of fillers or shims, in.; or
- (2) The fillers or shims shall be extended beyond the *joint* and the filler or shim extension shall be secured with enough bolts to uniformly distribute the total force in the connected element over the combined cross-section of the connected element and the fillers or shims; or
- (3) The size of the *joint* shall be increased to accommodate a number of bolts that is equivalent to the total number required in (2) above; or
- (4) The *joint* shall be designed as a *slip-critical joint* using Class A *faying surfaces* with the *turn-of-nut method*; or
- (5) The joint shall be designed as a *slip-critical joint* using Class B *faying surfaces*.

Table 5.1						
Nominal Strengths per Unit Area of Bolts						
Applied Load Condition		Nominal Strength per Unit Area, F_n , ksi				
		Group 120	Group 144	Group 150		
Tension^a	Static	90	108	113		
	Fatigue	See Section 5.5				
Shear^{a,b}	Threads included in shear plane	$L_s \leq 38$ in.	54	65	68	
		$L_s > 38$ in.	45	54	56	
	Threads excluded from shear plane	$L_s \leq 38$ in.	68	81	84	
		$L_s > 38$ in.	56	68	70	
^a Except as required in Section 5.2. ^b Reduction for values for $L_s > 38$ in. applies only when the <i>joint</i> is axially end loaded, such as splice plates on a beam or column flange, but it does not apply for web connections in shear.						

Commentary:

The nominal shear and tensile strengths of ASTM F3125 Grades A325, F1852, A490, and F2280 *high-strength bolts* as well as ASTM F3148 Grade 144 *matched bolting assemblies* are given in Table 5.1. These values are based upon the work of a large number of researchers throughout the world, as reported in the *Guide* and by others (Kulak et al., 1987; Tide, 2010; Roenker et al., 2017).

The nominal shear strength of a single *high-strength bolt* is taken as 0.625 times the tensile strength of that bolt (Kulak et al., 1987). In addition, a reduction factor of 0.90 is applied to *joints* up to 38 in. in length to account for an increase in bolt force due to minor secondary effects resulting from simplifying assumptions made in the modeling of structures that are commonly accepted in practice (e.g., equal force distribution in all the bolts of a shear *connection*). Second-order effects such as those resulting from the action of the applied loads on the deformed structure should be accounted for through a second-order analysis of the structure. The average shear strength of bolts in *joints* longer than 38 in. is reduced by a factor of 0.75 instead of 0.90. This factor accounts for both the non-uniform force distribution between the bolts in a long *joint* and the minor secondary effects discussed above. Note that the 0.75 reduction factor does not apply in cases where the distribution of force is essentially uniform along the *joint*, such as a web shear *connection* of a beam or girder.

The average ratio of nominal shear strength for bolts with threads included in the shear plane to the nominal shear strength for bolts with threads excluded from the shear plane is 0.83 with a standard deviation of 0.03 (Frank and Yura, 1981). Conservatively, a reduction factor of 0.80 is used to account for the reduction in shear strength for a bolt with threads included in the shear plane but calculated with the area corresponding to the nominal bolt diameter. The case of a bolt in double shear with a non-threaded section in one shear plane and a threaded section in the other shear plane is not covered in this Specification for two reasons. First, the manner in which load is shared between these two dissimilar shear areas is uncertain. Second, the detailer's lack of certainty as to the orientation of the bolt placement might leave both shear planes in the threaded section. Thus, if threads are included in one shear plane, the conservative assumption is made that threads are included in all shear planes.

The tensile strength of a *high-strength bolt* is the product of its ultimate tensile strength per unit area and some area through the threaded portion. This area, called the tensile stress area, is a derived quantity that is a function of the relative thread size and pitch. For the usual sizes of structural bolts, it is about 75 percent of the nominal cross-sectional area of the bolt. Hence, the nominal tensile strengths per unit area given in Table 5.1 are 0.75 times the tensile strength of the bolt material. According to Equation 5.1, the nominal area of the bolt is then used to calculate the *design strength* or *allowable strength* in tension. The strengths so calculated are intended to form the basis for comparison with the externally applied bolt tension plus any additional tension that results from *prying action* that is produced by deformation of the connected elements.

Reliability studies of bolts and bolted *joints* in shear have shown that the reliability indices for bolted *joints* is approximately 4.0 to 5.0 in most cases at a ratio of live load to dead load of $L/D = 3$ (Moore et al., 2008; Taylor et al., 2008; Tide, 2010; Roenker et al., 2017). The reliability is slightly higher for compact bolted *joints* than it is for intermediate length or long bolted *joints*, and the reliability of bolts with threads excluded from the shear plane is slightly higher than that of bolts with threads not excluded from the shear plane.

If *pretensioned* bolts are used in a *joint* that loads the bolts in tension, the question arises as to whether the *pretension* and the applied tension are additive. Because the compressed parts are being unloaded during the application of the external tensile force, the increase in bolt tension is minimal until the parts separate (Kulak et al., 1987). Thus, there will be little increase in bolt force above the *pretension* load under service loads. After the parts separate, the bolt acts as a tension member, as expected.

Pretensioned bolts have torsion present during the installation process. Once the installation is completed, any residual torsion is quite small and will disappear entirely when the bolt is loaded to the point of plate separation. Hence, there is no question of torsion-tension interaction when considering the ultimate tensile strength of a *high-strength bolt* (Kulak et al., 1987).

When required, *pretension* is induced in a bolt by imposing a small axial elongation during installation. When the *joint* is subsequently loaded in shear, tension, or combined shear and tension, the bolts will undergo significant deformations prior to failure that have the effect of overriding the small axial elongation that was introduced during installation, thereby removing the *pretension*. Measurements taken in laboratory tests confirm that the *pretension* that would be sustained if the applied load were removed is essentially zero before the bolt fails in shear (Kulak et al., 1987). Thus, the shear and tensile strengths of a bolt are not affected by the presence of an initial *pretension* in the bolt.

See also the Commentary to Section 5.5.

Tests of *connections* with 24 1 $\frac{1}{8}$ -in.-diameter A490 bolts indicated the reduction factor for bolt shear strength in *connections* with fillers as required in Section 5.1 (1) is limited to a minimum of 85 percent. (Borello et al., 2009).

5.2. Combined Shear and Tension

When combined shear and tension loads are transmitted by a Group 120, 144, or 150 bolt, the factored limit-state interaction shall be:

$$\left[\frac{T_u}{(\phi R_n)_t} \right]^2 + \left[\frac{V_u}{(\phi R_n)_v} \right]^2 \leq 1 \quad (\text{Equation 5.2a})$$

where

T_u = *required strength* in tension (factored tensile load) per bolt, kips

V_u = *required strength* in shear (factored shear load) per bolt, kips

$(\phi R_n)_t$ = *design strength* in tension determined in accordance with Section 5.1, kips

$(\phi R_n)_v$ = *design strength* in shear determined in accordance with Section 5.1, kips

When combined shear and tension loads are transmitted by a Group 120, 144, or 150 bolt, the allowable limit-state interaction shall be:

$$\left[\frac{T_a}{(R_n/\Omega)_t} \right]^2 + \left[\frac{V_a}{(R_n/\Omega)_v} \right]^2 \leq 1 \quad (\text{Equation 5.2b})$$

where

T_a = required strength in tension (service tensile load) per bolt, kips

V_a = required strength in shear (service shear load) per bolt, kips

$(R_n/\Omega)_t$ = allowable strength in tension determined in accordance with Section 5.1, kips

$(R_n/\Omega)_v$ = allowable strength in shear determined in accordance with Section 5.1, kips

Commentary:

When both shear forces and tensile forces act on a bolt, the interaction can be conveniently expressed as an elliptical solution (Chesson et al., 1965) that includes the elements of the bolt acting in shear alone and the bolt acting in tension alone. Although the elliptical solution provides the best estimate of the strength of bolts subject to combined shear and tension and is thus used in this Specification, the nature of the elliptical solution is such that it can be approximated conveniently using three straight lines (Carter et al., 1997). Earlier editions of this Specification have used such linear representations for the convenience of design calculations. The elliptical interaction equation in effect shows that, for design purposes, significant interaction does not occur until either force component exceeds 20 percent of the limiting strength for that component.

5.3. Nominal Bearing Strength at Bolt Holes

For *joints*, the nominal bearing strength shall be taken as the sum of the strengths of the connected material at the individual bolt holes.

The design bearing strength is ϕR_n , where $\phi = 0.75$ and the allowable bearing strength is R_n/Ω , where $\Omega = 2.00$ of the connected material at a standard bolt hole, oversized bolt hole, short-slotted bolt hole independent of the direction of loading, or long-slotted bolt hole with the slot parallel to the direction of the bearing load and:

- (1) When deformation of the bolt hole at service load is a design consideration,

$$R_n = 1.2L_c t F_u \leq 2.4d_b t F_u \quad (\text{Equation 5.3})$$

- (2) When deformation of the bolt hole at service load is not a design consideration,

$$R_n = 1.5L_c t F_u \leq 3d_b t F_u \quad (\text{Equation 5.4})$$

The design bearing strength is ϕR_n , where $\phi = 0.75$ and the allowable bearing strength is R_n/Ω , where $\Omega = 2.00$ of the connected material at a long-slotted bolt hole with the slot perpendicular to the direction of the bearing load and:

$$R_n = L_c t F_u \leq 2d_b t F_u \quad (\text{Equation 5.5})$$

In Equations 5.3, 5.4, and 5.5,

R_n = nominal strength (bearing strength of the connected material), kips

F_u = specified minimum tensile strength per unit area of the connected material, ksi

L_c = clear distance, in the direction of load, between the edge of the hole and the edge of the adjacent hole or the edge of the material, in.

d_b = nominal diameter of bolt, in.

t = thickness of the connected material, in.

Commentary:

The contact pressure at the interface between a bolt and the connected material can be expressed as a bearing stress on the bolt or on the connected material. The connected material is always critical. For simplicity, the bearing area is expressed as the bolt diameter times the thickness of the connected material in bearing. The governing value of the bearing stress has been determined from extensive experimental research, and a further limitation on strength was derived from the case of a bolt at the end of a tension member or near another bolt.

The design equations are based upon the models presented in the *Guide* (Kulak et al., 1987), except that the clear distance to another hole or edge is used in the Specification formulation rather than the bolt spacing or end distance as used in the *Guide* (see Figure C-5.1). Equation 5.3 is derived from tests (Kulak et al., 1987) that showed that the total elongation, including local bearing deformation, of a standard hole that is loaded to obtain the ultimate strength equal to $3d_b t F_u$ in Equation 5.4 was on the order of the diameter of the bolt.

This apparent hole elongation results largely from bearing deformation of the material that is immediately adjacent to the bolt. The lower value of $2.4d_b t F_u$ in Equation 5.3 provides a bearing strength limit-state that is attainable at reasonable deformation ($1/4$ in.). Strength and deformation limits were thus used to jointly evaluate bearing strength test results for design.

When long-slotted holes are oriented with the long dimension perpendicular to the direction of load, the bending component of the deformation in the material between adjacent holes or between the hole and the edge of the plate is increased. The nominal bearing strength is limited to $2d_b t F_u$, which again provides a bearing strength limit-state that is attainable at reasonable deformation.

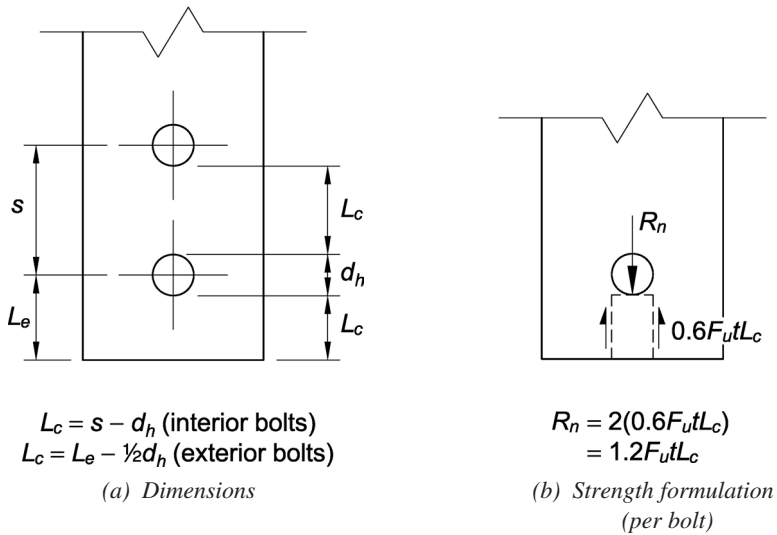

Figure. C-5.1. Bearing strength formulation.

5.4. Design Slip Resistance

Slip-critical joints shall be designed to prevent slip and for the limit states of bearing-type connections in accordance with Sections 5.1, 5.2, and 5.3. When bolts in *slip-critical joints* pass through fillers, all *faying surfaces* subject to slip shall be prepared to achieve design slip resistance.

At *LRFD* load levels the design slip resistance is ϕR_n , and at *ASD* load levels the allowable slip resistance is R_n/Ω where R_n , ϕ , and Ω are defined below.

The nominal slip resistance per bolt for the limit state of slip shall be determined as follows:

$$R_n = \mu D_u h_f T_m n_s k_{sc} \quad (\text{Equation 5.6})$$

For standard size and short-slotted holes perpendicular to the direction of the load:

$$\phi = 1.00 \text{ (LRFD)} \quad \Omega = 1.50 \text{ (ASD)}$$

For oversized and short-slotted holes parallel to the direction of the load:

$$\phi = 0.85 \text{ (LRFD)} \quad \Omega = 1.76 \text{ (ASD)}$$

For long-slotted holes:

$$\phi = 0.70 \text{ (LRFD)} \quad \Omega = 2.14 \text{ (ASD)}$$

where

μ = mean slip coefficient for Class A or B surfaces, as applicable, and determined as follows, or as established by tests:

- (1) For Class A surfaces (unpainted clean mill scale steel surfaces or surfaces with Class A coatings on blast-cleaned steel or hot-dipped galvanized)

$$\mu = 0.30$$

- (2) For Class B surfaces (unpainted blast-cleaned steel surfaces or surfaces with Class B coatings on blast-cleaned steel)

$$\mu = 0.50$$

D_u = 1.13 for building structures, 1.00 for bridge structures. Other values may be used with the approval by the *Engineer of Record* or by a Specification body

T_m = minimum bolt pretension given in Table 5.2, kips

h_f = factor for fillers, determined as follows:

- (1) Where there are no fillers or bolts have been added to distribute loads in the filler

$$h_f = 1.0$$

- (2) Where bolts have not been added to distribute the load in the filler:

- (i) For one filler between connected parts

$$h_f = 1.0$$

- (ii) For two or more fillers between connected parts

$$h_f = 0.85$$

n_s = number of slip planes required to permit the *connection* to slip

$$k_{sc} = 1 - \frac{T_u}{D_u T_m n_b} \geq 0 \quad (\text{LRFD}) \quad (\text{Equation 5.7a})$$

$$k_{sc} = 1 - \frac{1.5T_a}{D_u T_m n_b} \geq 0 \quad (\text{ASD}) \quad (\text{Equation 5.7b})$$

where

T_a = required tension force using *ASD load* combinations, kips

T_u = required tension force using *LRFD load* combinations, kips

n_b = number of bolts carrying the applied tension

Table 5.2
Minimum Bolt Pretension,
Pretensioned and Slip-Critical Joints

Nominal Bolt Diameter, d_b , in.	Specified Minimum Bolt Pretension, T_m , kips	
	Group 120	Group 144 and Group 150
½	12	15
5/8	19	24
¾	28	35
7/8	39	49
1	51	64
1 1/8	64	80
1 ¼	81	102
1 3/8	97	121
1 ½	118	148

Commentary:

The slip resistance of a *joint* is a function of the coefficient of friction, the bolt *pretension* (clamping force), the number of *faying surfaces*, and the number of bolts. In the equation for the nominal slip resistance per bolt (Equation 5.6), the clamping force is calculated as the product of the specified minimum *pretension*, T_m , and of a coefficient D_u . The specified minimum *pretensions* shown in Table 5.2 are based on 70 percent of the tensile strength of Group 120 or 150 fasteners computed as the product of their tensile strengths and tensile stress areas, rounded to the nearest kip. For the sake of simplicity, Group 144 bolts are required to be installed to the same minimum *pretensions* as Group 150 bolts.

The multiplier D_u in Equation 5.6 accounts for the statistical relationship between mean historical measured installed bolt *pretension* and the specified minimum bolt *pretension*, T_m . For the design of building structures, the value of $D_u = 1.13$ is used for installation by the *calibrated wrench method* (Kulak et al., 1987; Grondin et al., 2007). In the absence of other field test data, this value is used for all installation methods. *Turn-of-nut pretensioning* results in mean *pretensions* that are about 1.35 times the specified minimum *pretension* for ASTM F3125 Grade A325 bolts, and about 1.26 for Grade A490 bolts (Kulak et al., 1987; Grondin et al., 2007). *Twist-off tension control-* and *direct tension indicator-*installed *pretensions* are similar to those of a *calibrated wrench* (Grondin et al., 2007). The *combined method* of installation results in a D_u value of 1.37 for F3148 bolts (Roemaker et al., 2017). The bolt clamping force data indicate that bolt *pretensions* are distributed normally for each *pretensioning*

method. Field studies (Kulak and Birkemoe, 1993) of installed bolts in various structural applications indicate that the *pretensions* in Table 5.2 have been achieved as anticipated in the laboratory research.

For the design of bridge structures, a value of $D_u = 1.00$ is typically used. However, it is noted that in the AASHTO-LRFD Specification (AASHTO, 2020), the slip resistance of bolted *joints* is compared to loads that are computed using a different load combination than those used for checking the strength of main members and components.

In any of the foregoing installation methods, it can be expected that a portion of the bolt assembly (the threaded portion of the bolt within the *grip* length and/or the engaged threads of the nut and bolt) will reach the inelastic region of behavior. This permanent distortion has no undesirable effect on the subsequent performance of the bolt.

For most applications, the assumption that the slip resistance at each bolt is equal and additive with that at the other bolts is based on the fact that all locations must develop the slip force before a total *joint* slip can occur at that plane. Similarly, the forces developed at various slip planes do not necessarily develop simultaneously, but one can assume that the full slip resistances must be mobilized at each plane before full *joint* slip can occur.

Section 3.2.2(2) permits the *Engineer of Record* to authorize the use of *faying surfaces* with a *mean slip coefficient*, μ , that is less than 0.50 (Class B) and other than 0.30 (Class A). This authorization requires that the *mean slip coefficient*, μ , be determined in accordance with Appendix A.

In built-up compression members, such as double-angle struts in trusses, a small relative slip between the elements, especially at the end *connections*, can increase the effective length of the combined cross-section to that of the individual components and significantly reduce the compressive strength of the strut. Therefore, the *connection* between the elements at the ends of built-up members should be checked to prevent slip, whether or not a *slip-critical joint* is required for serviceability. As given by Sherman and Yura (1998), the required slip resistance is $0.08P_uLQ/I$, where P_u is the axial compressive force in the built-up member, kips; L is the total length of the built-up member, in.; Q is the first moment of area of one component about the axis of buckling of the built-up member, in.³; and I is the moment of inertia of the built-up member about the axis of buckling, in.⁴.

In *joints* with long-slotted holes that are parallel to the direction of the applied load, the *joint* is designed to prevent slip, however, the effect of the factored loads acting on the deformed structure (deformed by the maximum amount of slip in the long slots at all locations) should be included in the structural analysis.

In *joints* subject to fatigue, design should be based upon service-load criteria and the design slip resistance of the governing cyclic design specification because fatigue is a function of the service load performance rather than that of the factored load.

5.5. Tensile Fatigue

The tensile stress in the bolt that results from the cyclic application of externally applied service loads and prying forces, if any, but not the *pretension*, shall not exceed the stress in Table 5.3. The nominal diameter of the bolt shall be used in calculating the bolt stress. The connected parts shall be proportioned so that the calculated prying force does not exceed 30 percent of the externally applied load. *Joints* that are subject to tensile fatigue loading shall be specified as *pretensioned joints* in accordance with Section 4.2 or *slip-critical joints* in accordance with Section 4.3.

Table 5.3			
Maximum Applied Tensile Stress for Fatigue Loading			
Number of Cycles	Maximum Bolt Stress for Design at Service Loads ^a , ksi		
	Group 120	Group 144	Group 150
Not more than 20,000	45	45	57
From 20,000 to 500,000	40	40	49
More than 500,000	31	31	38

^a Including the effects of *prying action*, if any, but excluding the *pretension*.

Commentary:

As described in the Commentary to Section 5.1, *high-strength bolts* in *pretensioned joints* that are nominally loaded in tension will experience little, if any, increase in axial stress under service loads. For this reason, *pretensioned bolts* are not adversely affected by repeated application of service-load tensile stress. However, care must be taken to ensure that the calculated prying force is a relatively small part of the total applied bolt tension (Kulak et al., 1987). The provisions that cover bolt fatigue in tension are based upon research results where various single-bolt assemblies and *joints* with bolts in tension were subjected to repeated external loads that produced fatigue failure of the *pretensioned bolts*. A limited range of prying effects was investigated in this research.

SECTION 6. USE OF WASHERS**6.1. Snug-Tightened Joints Using Group 120, 144, or 150 Bolting Assemblies**

Washers are not required in *snug-tightened joints*, except as required in Sections 6.1.1 and 6.1.2.

- 6.1.1. Sloping Surfaces: When the outer face of the *joint* has a slope that is greater than 1:20 with respect to a plane that is normal to the bolt axis, an ASTM F436 beveled washer shall be used to compensate for the lack of parallelism.
- 6.1.2. Slotted Hole: When a slotted hole occurs in an outer ply, an ASTM F436 washer or $\frac{5}{16}$ -in. thick common plate washer shall be used as required to completely cover the hole.

6.2. Pretensioned Joints and Slip-Critical Joints Using Group 120, 144, or 150 Bolting Assemblies

Washers are not required in *pretensioned joints* and *slip-critical joints*, except as required in Sections 6.1.1, 6.1.2, 6.2.1, 6.2.2, 6.2.3, 6.2.4, 6.2.5, and 6.2.6.

- 6.2.1. Specified Minimum Yield Strength of Connected Material Less Than 40 ksi: When Group 144 or Group 150 bolts are *pretensioned* in connected material with specified minimum yield strength less than 40 ksi, ASTM F436 washers shall be used under both the bolt head and nut, except that a washer is not needed under the head of an ASTM F3125 Grade F2280 round head bolt or an ASTM F3148 Grade 144 round head bolt.
- 6.2.2. *Calibrated Wrench Method*: When the *calibrated wrench method* for *pretensioning* is used, an ASTM F436 washer shall be used under the nut.
- 6.2.3. *Twist-Off Tension-Control Bolt Method*: When the *twist-off tension control bolt method* for *pretensioning* is used, an ASTM F436 washer shall be used under the nut as part of the *bolting assembly*.
- 6.2.4. *Combined Method*: When the *combined method* for *pretensioning* is used, an ASTM F436 washer shall be used under the nut.
- 6.2.5. *Direct Tension Indicator Method*: When the *direct tension indicator method* for *pretensioning* is used, and the *direct tension indicator* is located under the turned element, an ASTM F436 washer shall be used between the turned element and the *direct tension indicator*.
- 6.2.6. Oversized or Slotted Hole: When an oversized or slotted hole occurs in an outer ply, the washer requirements shall be as given in Table 6.1. The washer used shall be of sufficient size to completely cover the hole.

Table 6.1
Washer Requirements for
Pretensioned and Slip-Critical
Bolted Joints with Oversized and
Slotted Holes in the Outer Ply

Bolt Group	Nominal Bolt Diameter, d_b , in.	Hole Type in Outer Ply		
		Oversized	Short-Slotted	Long-Slotted
Group 120	$\frac{1}{2} - 1\frac{1}{2}$	ASTM F436 ^a		$\frac{5}{16}$ -in.-thick plate washer or continuous bar ^{b,c}
Group 144 and 150	≤ 1			
		> 1	ASTM F436 extra thick ^{a,b,d}	ASTM F436 washer with either a $\frac{3}{8}$ -in.-thick plate washer or continuous bar ^{b,c}

^a This requirement shall not apply at the head at round heads of ASTM F3125 Grades F1852 and F2280, or F3148 Grade 144 *bolting assemblies* with round heads that meet the requirements in Section 2.4 and provide a bearing circle diameter that meets the requirements of the relevant ASTM Standard.

^b See ASTM F436 Section 1.2. Multiple washers with a combined thickness of $\frac{5}{16}$ in. or larger do not satisfy this requirement.

^c The plate washer or bar shall be of structural-grade steel material, but need not be hardened.

^d Alternatively, a $\frac{3}{8}$ -in.-thick plate washer and an ordinary thickness F436 washer may be used. The plate washer need not be hardened.

Commentary:

It is important that shop drawings and *connection* details clearly reflect the number and disposition of washers when they are required, especially the thick hardened washers or plate washers that are required for some oversized and slotted hole applications. The total thickness of washers and *direct tension indicators* used in a *bolting assembly* affects the length of bolt that must be supplied and used.

The primary function of washers is to provide a hardened non-galling surface under the turned element, particularly for torque-based *pretensioning methods* such as the *calibrated wrench method*, the *twist-off tension control method*, and the *combined method*. Circular flat washers that meet the requirements of ASTM F436 provide both a hardened non-galling surface and an increase in bearing area that is approximately 50 percent larger than that provided by a heavy hex bolt head or nut. However, tests have shown that washers of the standard $\frac{5}{32}$ -in. thickness have a minor influence on the pressure distribution of the induced bolt *pretension*. Furthermore, they showed that a larger thickness and surface bearing area is required when ASTM F3125 Grade A490 bolts are

used with material that has a minimum specified yield strength that is less than 40 ksi. This is necessary to mitigate the effects of local yielding of the material in the vicinity of the contact area of the head and nut.

With the 2011 revision of ASTM F436, special $\frac{5}{16}$ -in.-thick ASTM F436 washers are now called “extra thick.” Extra thick ASTM F436 washers are required to cover oversized and short-slotted holes in external plies, when ASTM F3125 Grade A490 or Grade F2280 or F3148 Grade 144 bolts of diameter larger than 1 in. are used, except as permitted by Table 6.1 footnotes a and d. This was found to be necessary to distribute the high clamping pressure so as to prevent collapse of the hole perimeter and enable the development of the desired clamping force. Preliminary investigation has shown that a similar but less severe deformation occurs when oversized or slotted holes are in the interior plies. The reduction in clamping force may be offset by “keying,” which tends to increase the resistance to slip. These effects are accentuated in *joints* of thin plies. When long-slotted holes occur in an outer ply, $\frac{3}{8}$ -in.-thick plate washers or continuous bars and one ASTM F436 washer are required in Table 6.1. This requirement can be satisfied with material of any structural grade. Alternatively, either of the following options can be used:

- (1) The use of material with F_y greater than 40 ksi will eliminate the need to also provide ASTM F436 washers in accordance with the requirements in Section 6.2.1 for ASTM F3125 Grade A490 or Grade F2280 or F3148 Grade 144 bolts of any diameter; or
- (2) Material with F_y equal to or less than 40 ksi can be used with ASTM F436 washers in accordance with the requirements in Section 6.2.1.

This specification previously required a washer under bolt heads with a bearing area smaller than that provided by an ASTM F436 washer. Tests indicate that the *pretension* achieved with a bolt having the minimum ASTM F3125 Grade F1852 or Grade F2280 bearing circle diameter is the same as that of a bolt with the larger bearing circle diameter equal to the size of an ASTM F436 washer, provided that the hole size meets the RCSC Specification limitations (Schnupp and Murray, 2003). Similar considerations apply to ASTM F3148 Grade 144 bolts with round heads.

SECTION 7. PRE-INSTALLATION VERIFICATION

The requirements in this Section shall apply only as required in Section 8.2.

Commentary:

Pre-installation Verification Testing is essential for:

- (1) Evaluating the suitability of the *bolting assembly*, including the lubrication that is applied by the *Manufacturer* or specially applied, to develop the specified minimum *pretension*;
- (2) Verifying the adequacy and proper use of the specified *pretensioning* method to be used;
- (3) Determining the installation torque for the *calibrated wrench method of pretensioning*;
- (4) Verifying the *initial torque* applied achieves at least the required *initial tension* when using the *combined method of pretensioning*; and
- (5) Demonstrating the suitability of the bolt tightening equipment to be used during installation.

Pre-installation verification testing provides a practical means for ensuring that non-conforming *bolting assemblies* are not incorporated into the work. Experience on many projects has shown that bolts, nuts, and/or *bolting assemblies* not meeting the requirements of the applicable ASTM standards would have been identified prior to installation if they had been tested as an assembly in a *bolt tension measurement device*. The expense of replacing bolts installed in the structure when the non-conforming bolts were discovered at a later date would have been avoided.

Additionally, pre-installation verification testing clarifies for the bolting crew and the *Inspector* the proper implementation of the selected *pretensioning* method and the adequacy of the installation equipment. It will also identify potential sources of problems, such as the need for lubrication (when permitted) to prevent failure of bolts by combined high torque with tension, under-strength assemblies resulting from excessive overtapping of hot-dip galvanized nuts, or other failures to meet strength or geometry requirements of applicable ASTM standards, such as the use of mismatched *bolting components* (e.g., a Grade C nut on an F3125 Grade A490 bolt).

7.1. Required Testing

Pre-installation verification testing shall be performed in compliance with all of the following:

- (1) At the site of installation;
- (2) Prior to the placement of *bolting assemblies* of verified lots in the work;
- (3) On a sample of not fewer than three complete *bolting assemblies* of each combination of diameter, length, grade, and *lot* to be used in the work;
- (4) Using *bolting assemblies* that are representative of the condition of those that will be *pretensioned* in the work;
- (5) Using ASTM F436 washers positioned in accordance with Section 6.2; and
- (6) In accordance with the test procedure in Section 7.2.

For *pretensioned* installation in accordance with Section 8.3.2 (*calibrated wrench method*), this testing shall be performed daily, prior to the installation, for the calibration of each installation wrench.

For *pretensioned* installation in accordance with Section 8.3.5 (*combined method*), this testing shall be performed at least weekly to verify that each installation tool continues to have the capability to produce the required *initial torque* used in the pre-installation verification testing in Table 7.3 for the *bolting assemblies* that are being installed. This weekly testing need only be performed on a single *lot* combination of three *bolting assemblies* for each installation tool.

Alternatively, if there is a means to measure the torque output of the tool while in use, this testing can be performed during installation.

Commentary:

The *bolting assemblies* and *bolting components* listed in Section 2 are manufactured under separate ASTM standards, each of which includes tolerances that are appropriate for the individual component covered. While these tolerances are intended to provide for a reasonable and workable fit between the components when used in an assembly, the cumulative effect of the individual tolerances permits a significant variation in the installation characteristics of the complete *bolting assembly*. It is the intent of this Specification that the responsibility rests with the *Supplier* for the proper performance of the *bolting assembly*, the components of which may have been produced by more than one *Manufacturer*.

When *pretensioned* installation is required, it is essential that the effects of the accumulation of tolerances, surface condition, and lubrication be taken into account. Hence, pre-installation verification testing of the complete *bolting assembly* is required as indicated in Section 8 to ensure that the *bolting assemblies* and installation method to be used in the work will provide a *pretension* that exceeds those specified in Table 5.2. It is not, however, intended to verify conformance with the individual ASTM standards.

The pre-installation verification requirements in this Section presume that *bolting assemblies* so verified will be *pretensioned* before the condition of the *bolting assemblies*, the equipment, and the steelwork have changed significantly. Research by Kulak and Undershute (1998) and by Tan et al. (2005) on *spline end twist-off bolt assemblies* from various *Manufacturers* showed that installed *pretensions* could be a function of the time and environmental conditions of storage and exposure. The reduced performance of these bolts was caused by a deterioration of the lubricity of the assemblies.

All bolt *pretensioning* that is achieved through rotation of the nut (or the bolt head) is affected by the reliance upon torque for tightening. *Bolting assemblies* that require high installation torque have demonstrated an adverse effect on the development of the desired *pretension*. Thus, it is required that the condition of the *bolting assemblies* must be replicated in pre-installation verification. When

the time of exposure between the placement of *bolting assemblies* in the fieldwork and the subsequent *pretensioning* of those *bolting assemblies* is of concern, pre-installation verification can be performed on *bolting assemblies* removed from the work or on extra *bolting assemblies* that, at the time of placement, were set aside to experience the same degree of exposure.

7.2. Test Procedure

The *bolting assembly* shall be tested in a *bolt tension measurement device* to verify that the *pretensioning* method to be used in the work develops a *pretension* that is equal to or greater than that specified in Table 7.1. The accuracy of the *bolt tension measurement device* shall be confirmed through calibration at least annually.

Impact wrenches, if used, shall be of adequate capacity and, if pneumatic, supplied with sufficient air to perform the required *pretensioning* of each bolt within approximately 10 seconds for bolts up to and including 1¼-in. diameter, and within approximately 15 seconds for larger bolts.

For the *calibrated wrench method*, the turned element shall be the nut.

Nominal Bolt Diameter, d_b , in.	Minimum Bolt Pretension for Pre-Installation Verification, kips	
	Group 120	Group 144 and Group 150
½	13	16
5/8	20	25
¾	29	37
7/8	41	51
1	54	67
1 1/8	67	84
1 ¼	85	107
1 3/8	102	127
1 ½	124	155

Pre-installation verification testing shall be performed as follows:

- (1) For *Turn-of-Nut Method* installation in accordance with Section 8.2.1, pre-installation verification testing shall be in accordance with Section 7.2.1,
- (2) For *Calibrated Wrench Method* installation in accordance with Section 8.2.2, pre-installation verification testing shall be in accordance with Section 7.2.2,

- (3) For *Twist-Off Tension Control Bolt Method* installation in accordance with Section 8.2.3, pre-installation verification testing shall be in accordance with Section 7.2.3,
- (4) For *Direct Tension Indicator Method* installation in accordance with Section 8.2.4, pre-installation verification testing shall be in accordance with Section 7.2.4, and
- (5) For *Combined Method* installation in accordance with Section 8.2.5, pre-installation verification testing shall be in accordance with Section 7.2.5.

7.2.1. *Turn-of-Nut Method*

Step 1: Snug-Tightening

The *bolting assembly* shall be installed to the *snug-tight condition* in the *bolt tension measurement device* using the tools, *bolting components*, assembly configuration, and installation methods to be used in the work.

Step 2: Matchmarking

If matchmarking is to be used in the work, the *bolting assembly* shall be match-marked.

Step 3: Pretensioning

The rotation specified in Table 8.1 shall be applied to the *bolting assembly*.

Step 4: Final Verification

If the actual *pretension* developed in the *bolting assembly* is less than that specified in Table 7.1, the cause(s) shall be determined and resolved before the *bolting assemblies* are used in the work. Cleaning, lubrication, and retesting of these *bolting assemblies* is permitted provided that all assemblies are treated in the same manner.

7.2.2. *Calibrated Wrench Method*

Step 1: Snug-Tightening

The *bolting assembly* shall be installed to the *snug-tight condition* in the *bolt tension measurement device* using the tools, *bolting components*, assembly configuration, and installation methods to be used in the work.

Step 2: Pretensioning

The torque required for the installation tool to develop a *pretension* in the *bolting assembly* equal to or greater than that specified in Table 7.1 shall be determined. The installation torque shall be applied to the nut. The highest torque measured from the three assemblies tested shall be the minimum installation torque to be used in the work.

7.2.3. *Twist-Off Tension Control Bolt Method*

Step 1: Snug-Tightening

The *bolting assembly* shall be installed to the *snug-tight condition* using the tools, *bolting components*, assembly configuration, and installation methods to be used in the work.

Step 2: Intermediate Verification

It shall be verified that the splined end is not severed.

Step 3: Pretensioning

The *twist-off tension control bolt* installation wrench shall be used to sever the splined end from the bolt.

Step 4: Final Verification

It shall be verified that the splined end is severed. If the actual *pretension* developed in the *bolting assembly* is less than that specified in Table 7.1, the cause(s) shall be determined and resolved before the *bolting assemblies* are used in the work. Cleaning, lubrication, and retesting of these *bolting assemblies* is not permitted, except as allowed in Section 2.10, provided that all assemblies are treated in the same manner.

7.2.4. *Direct Tension Indicator Method*

Step 1: Snug-Tightening

The *bolting assembly* shall be installed to the *snug-tight condition* using the tools, *bolting components*, assembly configuration, and installation methods to be used in the work. *Snug tightening* shall not exceed the *pretension* specified in Table 7.1.

Step 2: Intermediate Verification

The *bolting assembly* shall be further tightened to a *pretension* that is equal to that required in Table 7.1. It shall then be verified that the *job inspection gap* has not closed prematurely. To prove acceptability, the feeler gage used to verify the *job inspection gap* shall be able to be inserted in half or more of the spaces between the protrusions of the *direct tension indicator*. Verification with the feeler gage in this step satisfies verification for both Step 1 and Step 2.

Step 3: Pretensioning

The *bolting assembly* shall be further tightened, as needed, until the feeler gage is refused (i.e., cannot be inserted) in more than half of the spaces between the protrusions of the *direct tension indicator*.

Step 4: Final Verification

It shall be verified that the pretension achieved is at least that specified in Table 7.1. If the actual *pretension* developed in the *bolting assembly* is less than that specified in Table 7.1, the cause(s) shall be determined and resolved before the *bolting assemblies* are used in the work. Cleaning, lubrication, and retesting of these *bolting assemblies* is permitted provided that all assemblies are treated in the same manner.

7.2.5. *Combined Method*

Step 1: Initial Tensioning

The *bolting assembly* shall be installed in the *bolt tension measurement device* using the tools, *bolting components*, assembly configuration, and installation methods to be used in the work. The *initial torque* shall be applied to the nut. If the *initial torque* has not been provided by the *Supplier*, then the torque in Table 7.3 shall be used. Tools used shall demonstrate or have certified output that does not vary by more than ± 10 percent during use.

Step 2: Intermediate Verification

If the actual tension developed in the *bolting assembly* is less than the *initial tension* specified in Table 7.2, the cause(s) shall be determined and resolved before the *bolting assemblies* are used in the work. Cleaning, lubrication, and retesting of these *bolting assemblies* is not permitted, except as allowed in Section 2.10, provided that all assemblies are treated in the same manner.

Step 3: Pretensioning

If match-marking is to be used in the work, the *bolting assembly* shall be match-marked. The rotation specified in Table 8.2 shall be applied to the *bolting assembly*.

Step 4: Final Verification

If the actual *pretension* developed in the *bolting assembly* is less than that specified in Table 7.1, the cause(s) shall be determined and resolved before the *bolting assemblies* are used in the work.

Table 7.2
Minimum Initial Tension for
Pre-Installation Verification of
Installation in Accordance with
Section 8.2.5 (Combined Method)

Nominal Bolt Diameter, d_b , in.	Minimum Initial Tension for Pre-Installation Verification, kips	
	Group 120	Group 144 and Group 150
1/2	5	7
5/8	9	11
3/4	13	16
7/8	17	22
1	23	29
1 1/8	29	36
1 1/4	37	46
1 3/8	44	55
1 1/2	53	66

Table 7.3
Default Initial Torque Range for
Pre-installation Verification of Initial
Tension in Accordance with Section
8.2.5 (Combined Method)

Nominal Bolt Diameter, d_b , in.	Torque Range for Pre-Installation Verification, lb-ft ^a			
	Group 120		Group 144 ^b and Group 150	
	Min	Max	Min	Max
1/2	45	50	60	75
5/8	100	120	120	145
3/4	170	205	210	250
7/8	260	310	335	400
1	405	480	510	605
1 1/8	570	680	710	845
1 1/4	810	965	1010	1200
1 3/8	1060	1260	1325	1575
1 1/2	1390	1655	1735	2065

^a This table shall not be used in lieu of *Supplier*-provided torque values and shall only be used when torque has not been provided for a *bolting assembly* by the bolt *Supplier*.

^b F3148 Group 144 *bolting assemblies* are only available up to 1 1/4-in. diameter.

Commentary:

A *bolt tension measurement device* must be readily available whenever *high-strength bolts* are to be *pretensioned*.

Hydraulic *bolt tension measurement devices* undergo a slight deformation during bolt *pretensioning*. Hence, when bolts are *pretensioned* according to Section 8.2.1, the nut rotation corresponding to a given *pretension* reading may be somewhat larger than it would be if the same bolt were *pretensioned* in a solid steel assembly. Stated differently, the reading of a hydraulic *bolt tension measurement device* tends to underestimate the *pretension* that a given rotation of the turned element would induce in a bolt in a *pretensioned joint*.

Direct tension indicators (DTIs) may be used as *bolt tension measurement devices*, except in the case of the *turn-of-nut method* and the *combined method*. This method is especially useful for, but not restricted to, bolts that are too short to fit into a hydraulic *bolt tension measurement device*. The DTIs to be used for verification testing must first have the average gap determined for the specific level of *pretension* required by Table 7.1, measured to the nearest 0.001 in. This is termed the “*calibrated gap*.” Such measurements should be made for each *lot* of DTIs being used for verification testing, termed the “*verification lot*.” The *bolting assembly* may then be installed in a standard size hole with the additional verification DTI. The prescribed *pretensioning* procedure is followed, and it is verified that the average gap in the verification DTI is equal to or less than the *calibrated gap* for the verification *lot*. For *calibrated wrench installation*, the verification DTI should be placed at the head. For *twist-off tension control bolt method* installation, the verification DTI must be placed beneath the bolt head, with an additional ASTM F436 washer between the bolt head and verification DTI, and the bolt head is not permitted to turn. For DTI installation, the verification DTI must be placed at the end opposite the placement of the production DTI.

This technique cannot be used for the *turn-of-nut method* or for the *combined method* because the deformation of the DTI consumes a portion of the turns provided. For *turn-of-nut method* pre-installation verification of bolts too short to fit into a *bolt tension measurement device*, installing the *bolting assembly* in a steel plate with the proper size hole and applying the required turns is adequate. The assembly is then to be removed from the steel plate using a wrench to confirm that stripping has not occurred. No verification is required for achieved *pretension* to meet Table 7.1. This test demonstrates that the *bolting assembly* will not fracture or strip during tightening, and the *turn-of-nut method* assures a strain that will produce the minimum required *pretension*.

It is recognized in this Specification that a natural scatter is found in the results of the pre-installation verification testing that is required in Section 8.2. Furthermore, it is recognized that the *pretensions* developed in tests of a representative sample of the *bolting components* that will be installed in the work must be slightly higher to provide confidence that the majority of *bolting assemblies* will achieve the minimum required *pretension* as given in Table 5.2. Accordingly, the minimum *pretension* to be used in pre-installation verification is 1.05 times that required for installation and inspection, rounded to the nearest kip.

The minimum initial bolt tension for pre-installation verification of installation in accordance with Section 8.2.5 (*Combined Method*) is 0.45 multiplied by the specified minimum bolt tensions rounded to the nearest kip.

SECTION 8. INSTALLATION

The storage and lubrication of *bolting assemblies* and *bolting components* shall comply with the requirements of Section 2.10. For *joints* that are designated in the contract documents as *snug-tightened joints*, the *bolting assemblies* shall be installed in accordance with Section 8.1. For *joints* that are designated in the contract documents as *pretensioned joints* or *slip-critical joints*, the *bolting assemblies* shall be installed in accordance with Section 8.2.

8.1. Snug-Tightened Joints

Snug-tightened joints shall comply with all of the following:

- (1) All bolt holes shall be aligned to permit insertion of the bolts without undue damage to the threads;
- (2) Bolts shall be placed in all holes with washers positioned as required in Section 6.1 and nuts threaded to complete the assembly;
- (3) Compacting the *joint* shall progress systematically from the most rigid part of the *joint*; and
- (4) The *joint* shall be installed to the *snug-tight condition* with *sufficient thread engagement*.

Commentary:

As discussed in the Commentary to Section 4, the bolted *joints* in most shear *connections* and in many tension *connections* can be specified as *snug-tightened joints*. The *snug-tightened condition* is typically achieved with a few impacts of an impact wrench, application of an electric torque wrench until the wrench begins to slow, or the full effort of a worker on an ordinary spud wrench. More than one cycle through the bolt pattern may be required to achieve the *snug-tightened condition*.

The splines on *spline end twist-off bolts* may be twisted off or left in place in *snug-tightened joints*.

The actual tensions that result in individual bolts in *snug-tightened joints* will vary from *joint* to *joint* depending upon the thickness, flatness, and degree of parallelism of the connected plies, as well as the effort applied. In most *joints*, plies of *joints* involving material of ordinary thickness and flatness can be drawn into *firm contact* at relatively low levels of bolt tension. However, in some *joints* in thick material or in material with large burrs, it may not be possible to achieve *faying surface* contact at all bolt hole locations as is commonly achieved in *joints* of thinner plates. This is generally not detrimental to the performance of the *joint*.

As used in Section 8.1, the term “undue damage” is intended to mean damage that would be sufficient to render the product unfit for its intended use.

The definition of a *snug-tightened joint* was temporarily changed in the 2009 specification and, in the 2014 edition, reverted back to the same definition specified in 2004. While the 2009 definition was suitable for inspection of *snug-tightened joints* and *shear/bearing joints installed with other methods*, that definition was found to be inadequate to define a suitable starting point for the *turn-of-nut method*.

8.2. Pretensioned Joints and Slip-Critical Joints

The pre-installation verification procedures specified in Section 7 shall be performed using *bolting assemblies* that are representative of the condition of those that will be *pretensioned* in the work.

(1) *Pretensioning methods*

One of the following installation methods shall be used to *pretension* the *bolting assemblies* in the joint:

- a. For Group 120 or 150 *bolting assemblies*, one of the *pretensioning* methods in Sections 8.2.1 through 8.2.5 shall be used;
- b. For ASTM F3148 Grade 144 *matched bolting assemblies*, the *pretensioning* method in Section 8.2.5 shall be used; and
- c. For alternative-design *bolting components* or *assemblies* that meet the requirements of Section 2.12, the installation instructions provided by the consensus standard or *Manufacturer* and approved by the *Engineer of Record* shall be used.

(2) Procedures for *pretensioned* installation in accordance with Sections 8.2.1 through 8.2.4,

- a. All *bolting assemblies* shall be installed to the *snug-tight condition* in accordance with the requirements in Section 8.1, with washers positioned as required in Section 6.2; and
- b. Subsequently, the installation method verified for the *bolting assemblies* shall be used as specified in Sections 8.2.1 through 8.2.4.

(3) For *pretensioned* installation in accordance with Section 8.2.5,

- a. All *bolting assemblies* shall be installed in accordance with the requirements in Section 8.1 (1), (2), and (3) with washers positioned as required in Section 6.2. Each *bolting assembly* shall have been tightened by application of the *initial torque* used in the pre-installation verification testing, and the plies shall have been brought into *firm contact* with *sufficient thread engagement*. The *initial torque* shall be applied only by turning the nut
- b. Subsequently, the *bolting assemblies* shall be installed as specified in Section 8.2.5.

For all methods, the part not turned by the wrench shall be prevented from rotating during *pretensioning*. When it is impractical to turn the nut, *pretensioning* by turning the bolt head is permitted while rotation of the nut is prevented, provided that the washer requirements in Section 6.2 are met and the *calibrated wrench method* of *pretensioning* is not used. Upon completion of the *pretensioning*, it is not permitted to turn the nut or the head in the loosening direction except for the purpose of complete removal of the individual *bolting assembly*. Removed *bolting assemblies* shall not be *reused* except as permitted in Section 2.11.

Commentary:

Five *pretensioning methods* are provided without preference in this Specification. Each method may be relied upon to provide satisfactory results when conscientiously implemented with the specified *bolting components* or *assemblies* in good condition. However, it must be recognized that misuse or abuse is possible with any method. With all installation methods, it is important to first install bolts in all holes of the *joint* and to compact the *joint* until the connected plies are in *firm contact*. Only after completion of this operation can the *joint* be reliably *pretensioned*. Both the initial phase of compacting the *joint* and the subsequent phase of *pretensioning* should begin at the most rigidly fixed or stiffest point.

In some *joints* in thick material, it may not be possible to reach continuous contact throughout the *faying surface* area, as is commonly achieved in *joints* of thinner plates. This is not detrimental to the performance of the *joint*. If the specified *pretension* is present in all *bolting assemblies* of the completed *joint*, the clamping force, which is equal to the total of the *pretensions* in all *bolting assemblies*, will be transferred at the locations that are in contact and the *joint* will be fully effective in resisting slip through friction.

If individual *bolting assemblies* are *pretensioned* in a single continuous operation in a *joint* that has not first been properly compacted or fitted up, the *pretension* in the *bolting assemblies* that are *pretensioned* first may be relaxed or removed by the *pretensioning* of adjacent *bolting assemblies*. The resulting reduction in total clamping force will reduce the slip resistance.

In the case of galvanized coatings, especially if the *joint* consists of many plies of thickly coated material, relaxation of bolt *pretension* may be significant and re-*pretensioning* of the *bolting assemblies* may be required subsequent to the initial *pretensioning*. Munse (1967) showed that a loss of *pretension* of approximately 6.5 percent occurred for galvanized plates and bolts due to relaxation as compared with 2.5 percent for *uncoated joints*. This loss of bolt *pretension* occurred in five days; loss recorded thereafter was negligible. Either this loss can be allowed for in design, or *pretension* may be brought back to the prescribed level by re-*pretensioning* the bolts after an initial period of “settling-in.” If re-*pretensioning* of galvanized *joints* is required by the *Engineer of Record*, this must be clearly specified in the contract documents.

As stated in the *Guide* (Kulak et al., 1987), “...it seems reasonable to expect an increase in bolt force relaxation as the *grip* length is decreased. Similarly, increasing the number of plies for a constant *grip* length might also lead to an increase in bolt relaxation.”

8.2.1. Turn-of-Nut Method Pretensioning

After the snug-tightening operation has been performed, the nut or head rotation specified in Table 8.1 shall be applied to all *bolting assemblies* in the *joint*, progressing systematically from the most rigid part of the *joint* in a manner that will minimize relaxation of previously *pretensioned bolting assemblies*.

Table 8.1
Nut Rotation from Snug-Tight
Condition for Turn-of-Nut
Method Pretensioning^{a,b}

Bolt Length ^c	Disposition of Outer Faces of Bolted Parts		
	Both Faces Normal to Bolt Axis	One Face Normal to Bolt Axis, Other Sloped Not More Than 1:20 ^d	Both Faces Sloped Not More Than 1:20 from Normal to Bolt Axis ^d
Not more than $4d_b$	1/3 turn	1/2 turn	2/3 turn
More than $4d_b$ but not more than $8d_b$	1/2 turn	2/3 turn	5/6 turn
More than $8d_b$ but not more than $12d_b$	2/3 turn	5/6 turn	1 turn

a Nut rotation is relative to bolt regardless of the element (nut or bolt) being turned. For all required nut rotations, the tolerance is plus 60 degrees (1/2 turn) and minus 0 degrees.
b Applicable only to joints in which all material within the *grip* is steel.
c When the bolt length exceeds $12d_b$, the required nut rotation shall be determined by actual testing in a suitable *bolt tension measurement device*; see *turn-of-nut* Commentary.
d Beveled washer not used.

Commentary:

The *turn-of-nut method* of *pretensioning* results in more reliable bolt *pretensions* than are generally provided with torque-controlled *pretensioning methods*. Strain-control that reaches the inelastic region of bolt behavior is inherently more reliable than a method that is completely dependent upon torque control. However, proper implementation is dependent upon ensuring that the *joint* is properly compacted prior to application of the required partial turn and that the bolt head (or nut) remains stationary when the nut (or bolt head) is being turned.

Match-marking of the nut and protruding end of the bolt after snug-tightening can be helpful in the subsequent installation process and is certainly an aid to inspection.

As indicated in Table 8.1, there is no available research that establishes the required nut rotation for bolt lengths exceeding $12d_b$. The required turn for such bolts can be established on a case-by-case basis using a *bolt tension measurement device*. When the *turn-of-nut method* is to be used, and the bolt length exceeds 12 bolt diameters, Table 8.1 note c requires testing in a *bolt tension measurement device* to establish the required nut rotation, similar to pre-installation verification testing as described in Section 7. The following procedure may be used:

- (1) Test three samples of each combination of bolt and nut *lot* to be used in the work.
- (2) Place the bolt in the *bolt tension measurement device*. The *Manufacturer's* instructions of the selected *bolt tension measurement device* should be properly followed and should include requirements for the proper placement of

spacers and/or bushings to reduce the *prying action* that results from excessive stick-out at the turned element so that accurate tension testing for long bolts can be achieved.

- (3) Install the *bolting assembly* to the requirements of Section 8.1 using the tools and installation methods to be used in the work.
- (4) Determine the rotation from the *snug-tight condition* required to develop a *pretension* in the *bolting assembly* equal to or greater than that specified in Table 7.1.
- (5) For the convenience of the installer, round the rotation up to the next higher $\frac{1}{6}$ -turn increment (e.g., if 270 degrees ($\frac{3}{4}$ turn) is required, round up to $\frac{5}{6}$ turn).
- (6) If the resultant rotation requirement is less than that provided in Table 8.1, use the value for 12 bolt diameters (d_b) as provided in Table 8.1.

Significant research indicates that, at rotations exceeding those specified in Table 8.1, the level of *pretension* in the bolt will still be above the specified minimum *pretension*. In addition, the *pretension* is likely to remain high until just prior to failure of the bolt. The rotational margin against bolt failure is large. A325 and A490 bolts $\frac{7}{8}$ in. diameter and 5 $\frac{1}{2}$ in. long with $\frac{1}{8}$ in. of thread in the *grip* were tested. The installation condition for bolts of this length and diameter is $\frac{1}{2}$ turn past snug. The A325 bolts did not fail until about 1 $\frac{3}{4}$ turns past snug, and the A490 bolts did not fail until about 1 $\frac{1}{4}$ turns past snug. Bolts with additional threads in the *grip* would exhibit additional ductility and tolerance for over-rotation.

Non-heat-treated nuts (ASTM A563 Grades C, C3, and D) manufactured near the lower range of permitted strength and hardness may strip if the bolt is tightened far beyond the specified level of *pretension*. For Group 120 bolts, nuts with a hardness of 89 HRB or higher should have adequate resistance to thread stripping. For Group 150 bolts, only heat-treated nuts are used. Deliberate over-rotation should be avoided to minimize risk of inducing nut stripping with low-hardness nuts or inducing nut cracking with high-hardness and heat-treated nuts. Nut stripping or cracking would be considered cause for rejection of the installed *bolting assembly*.

8.2.2. Calibrated Wrench Method Pretensioning

After the snug-tightening operation has been performed, the installation torque determined in the pre-installation verification of the *bolting assembly* (Section 7.2.2) shall be applied by turning the nuts (not the bolt heads) in the *joint*, progressing systematically from the most rigid part of the *joint* in a manner that will minimize relaxation of previously *pretensioned bolting assemblies*. It is prohibited to use this method by turning the bolt head. Torque values determined from tables or from equations that claim to relate torque to *pretension* without verification shall not be used.

Application of the installation torque need not produce a relative rotation between the bolt and nut that is equal to or greater than the rotation specified in Table 8.1.

Commentary:

The scatter in installed *pretension* can be significant when torque-controlled methods of installation are used. The variables that affect the relationship between torque and *pretension* include:

- (1) The finish and tolerance on the bolt and nut threads;
- (2) The uniformity, degree, and condition of lubrication;
- (3) The shop or job-site conditions that contribute to dust, dirt, or corrosion on the threads or mating nut and washer surfaces;
- (4) The friction that exists to a varying degree between the turned element (the nut face or bearing area of the bolt head) and the supporting surface;
- (5) The variability of the air supply parameters on pneumatic impact wrenches that results from the length of air lines or number of wrenches operating from the same source;
- (6) The condition, lubrication, and power supply for the torque wrench, which may change within a work shift; and
- (7) The repeatability of the performance of any wrench that senses or responds to the level of the applied torque.

The nut must be the turned element when using the *calibrated wrench method*. If the bolt was the turned element, the potential friction between the bolt shaft and the surrounding steel plies would be highly unpredictable, rendering the calibration performed in a *bolt tension measurement device* unreliable.

In the first edition of this Specification, which was published in 1951, a table of torque-to-*pretension* relationships for bolts of various diameters was included. It was soon demonstrated in research that a variation in the torque-to-*pretension* ratio as high as ± 40 percent must be anticipated unless the relationship is established individually for each bolt *lot*, diameter, and *bolting component* condition. Hence, in the 1954 edition of this Specification, recognition of relationships between torque and *pretension* in the form of tabulated values or equations was withdrawn. However, recognition of the *calibrated wrench method of pretensioning* was retained until 1980, but with the requirement that the torque required for installation be determined specifically for the bolts being installed on a daily basis. Recognition of the method was withdrawn in 1980 because of the continuing controversy that resulted from the failure of users to adhere to the requirements for the valid use of the method during both installation and inspection.

In the 1985 edition of this Specification, the *calibrated wrench method of pretensioning* was reinstated, but with more emphasis on detailed requirements that must be carefully followed. For *calibrated wrench method pretensioning*, wrenches must be calibrated:

- (1) Daily;
- (2) When the *lot* of any component of the *bolting assembly* is changed;
- (3) When any component of the *bolting assembly* is relubricated;
- (4) When significant differences are noted in the surface condition of the bolt threads, nuts, or washers; or

- (5) When any major component of the wrench—including lubrication, hose, and air supply—are altered.

It is also important that:

- (1) *Bolting components* are protected from dirt and moisture at the shop or job site as required in Section 2.10;
- (2) Washers are used as specified in Section 6;
- (3) The time between removal from *protected storage*, wrench calibration, and final *pretensioning* is minimal; and
- (4) Only the nut is to be turned during calibration and installation.

8.2.3. Twist-Off Tension Control Bolt Method Pretensioning

After the snug-tightening operation is performed, the installer shall verify that the splined end has not been severed, and if this has occurred, the *bolting assembly* shall be removed and replaced.

All bolts in the *joint* shall be *pretensioned* with the *spline end twist-off bolt* installation wrench, progressing systematically from the most rigid part of the *joint* in a manner that will minimize relaxation of previously *pretensioned* bolts.

Commentary:

Spline end twist-off matched bolting assemblies have a splined end that extends beyond the threaded portion of the bolt. During installation, this splined end is gripped by a specially designed wrench chuck and provides a means for turning the nut relative to the bolt. This product is, in fact, based upon a torque-controlled installation method to which the *bolting assembly* variables affecting torque that were discussed in the Commentary to Section 8.2.2 apply, except for wrench calibration, because torque is controlled within the *bolting assembly*.

Spline end twist-off matched bolting assemblies must be used in the as-delivered, clean, lubricated condition as specified in Section 2. Adherence to the requirements in this Specification, especially those for storage, cleanliness, and verification, is necessary for their proper use.

8.2.4. Direct Tension Indicator Method Pretensioning

After the snug-tightening operation is performed, the installer shall verify that the *direct tension indicator* protrusions have not been compressed to a gap that is less than the *job inspection gap* in half or more of the locations, and if this has occurred, the *direct tension indicator* shall be removed and replaced.

All bolts in the *joint* shall be *pretensioned*, progressing systematically from the most rigid part of the *joint* in a manner that will minimize relaxation of previously *pretensioned* bolts. The installer shall verify that the *direct tension indicator* protrusions have been compressed to a gap that is less than the *job inspection gap* in more than half of the locations.

Commentary:

Direct tension indicators are recognized in this Specification as a *bolt tension measurement device*. *Direct tension indicators* are washer-shaped devices incorporating small arch-like protrusions on the bearing surface that are designed to deform in a controlled manner when subjected to compressive load.

During installation, care must be taken to ensure that the *direct tension indicator* protrusions are oriented to bear against the hardened bearing surface of the bolt head or nut or against a hardened flat washer if used under the turned element, whether that turned element is the nut or the bolt. Proper use and orientation is illustrated in Figure C-8.1.

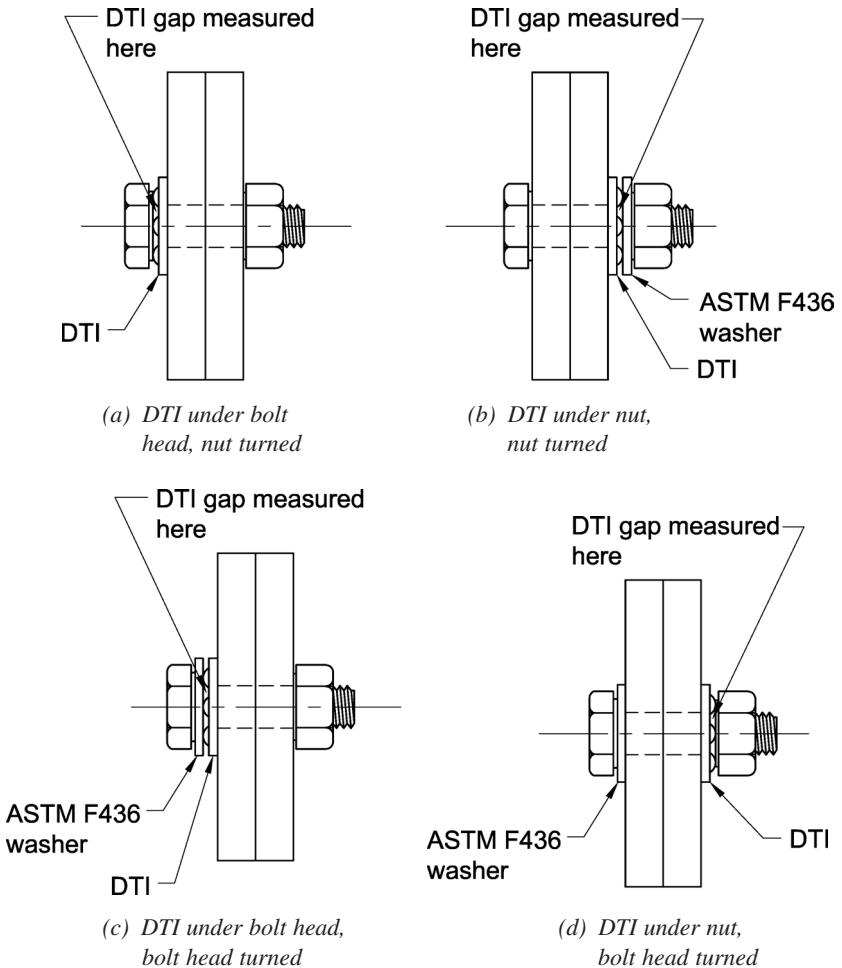

Note: See Section 6 for general requirements for the use of washers.

Figure C-8.1. Proper use and orientation of ASTM F959 direct tension indicators.

In some cases, more than a single cycle of systematic partial *pretensioning* may be required to deform the *direct tension indicator* protrusions to the gap that is specified by the *Manufacturer*. If the gaps fail to close or when the washer *lot* is changed, another verification procedure using the *bolt tension measurement device* must be performed.

Provided the connected plies are in *firm contact*, partial compression of the *direct tension indicator* protrusions is commonly taken as an indication that the *snug-tight condition* has been achieved.

8.2.5. Combined Method Pretensioning

After the application of the *initial torque* and when the plies have been brought into *firm contact*, the rotation specified in Table 8.2 shall be applied to all *bolting assemblies* in the *joint*, progressing systematically from the most rigid part of the *joint* in a manner that will minimize relaxation of previously *pretensioned bolting assemblies*.

Table 8.2
Nut Rotation from
Initial Torque for Combined
Method Pretensioning^{a,b}

Bolt Length ^c	Rotation
Not more than $4d_b$	90° (¼ turn)
More than $4d_b$ but not more than $8d_b$	120° (⅓ turn)

^a Nut rotation is relative to bolt regardless of the element (nut or bolt) being turned. For all required nut rotations, the tolerance is plus 45 degrees (½ turn) and minus 0 degrees.
^b Applicable only to *joints* in which all material within the *grip* is steel.
^c When the bolt length exceeds $8d_b$, the required nut rotation shall be determined by actual testing in a suitable *bolt tension measurement device*; see *combined method* Commentary.

Commentary:

The *combined method* relies on an established relationship between fastener torque and tension to achieve or surpass the prescribed *initial tension*. Next, the bolt or nut is rotated by a designated additional amount relative to the bolt to reliably achieve the minimum specified *pretension*. This final *pretensioning* step is similar to the *turn-of-nut method*, but the angle of rotation is different and likely less because it is relative to the *initial tension* condition of the *combined method*, which is usually higher than the minimum snug condition required for the *turn-of-nut method*. Matchmarking of the nut and protruding end of the bolt after initial tensioning can be helpful in subsequent installation and as an aid to inspection.

Bolting assemblies used for the *combined method* should be treated as *matched bolting assemblies*.

As indicated in Table 8.2, there is no available research that establishes the required nut rotation for bolt lengths exceeding $8d_b$. In the absence of procedures provided by the *Manufacturer*, the required turn for such bolts can be established on a case-by-case basis using a *bolt tension measurement device*.

When the *combined method* is to be used and the bolt length exceeds $8d_b$, Table 8.2. note c requires testing in a *bolt tension measurement device* to establish the required nut rotation, similar to pre-installation verification testing as described in Section 7.

- (1) Test three samples of each *bolting assembly* to be used in the work.
- (2) Place the bolt in the *bolt tension measurement device*. The *Manufacturer's* instructions of the selected *bolt tension measurement device* should be properly followed and should include requirements for the proper placement of spacers and/or bushings to reduce the *prying action* that results from excessive stick-out at the turned element, so that accurate tension testing for long bolts can be achieved.
- (3) Install the *bolting assembly* to the *initial tension* requirements of Section 7.2.5 using the tools and installation methods to be used in the work.
- (4) Determine the rotation from the *initial tension* condition required to develop a *pretension* in the *bolting assembly* equal to or greater than that specified in Table 7.1.
- (5) For the convenience of the installer, round the rotation up to the next higher $\frac{1}{6}$ -turn increment (e.g., if 150 degrees is required, round up to $\frac{1}{2}$ turn).
- (6) If the resulting rotation requirement is less than that provided in Table 8.2, use the value for a bolt length up to 8 bolt diameters as provided in Table 8.2.

SECTION 9. INSPECTION

Inspection tasks prior to bolting and during bolting shall be performed in accordance with the invoking specification or standard and as required in this Section.

Commentary:

For buildings, Chapter N, Section 6 of AISC 360 contains requirements for inspection of high-strength bolting. In particular, inspection tasks prior to, during, and after bolting are summarized in Tables N5.6-1, N5.6-2, and N5.6-3 of AISC 360, respectively.

Generally, torque measurements do not provide consistent results for inspection, as they are greatly dependent on the friction between bearing faces and threads and area influenced by the lubrication conditions of the *bolting components*. *Routine observation* of installation methods is always preferred.

9.1. Snug-Tightened Joints

Prior to the *start of work*, it shall be verified that all *bolting components* to be used in the work meet the requirements in Section 2. Subsequently, it shall be verified that all connected plies meet the requirements in Section 3.1 and all bolt holes meet the requirements in Sections 3.3 and 3.4. After the *connections* have been assembled to the requirements of Section 8.1, it shall be visually verified that the plies of the connected elements have been brought into *firm contact* and that washers have been used as required in Section 6. No further evidence of conformity is required for *snug-tightened joints*.

Commentary:

Inspection requirements for *snug-tightened joints* consist of verification that the proper *bolting components* were used, the connected elements were fabricated properly, and the bolted *joint* was drawn into *firm contact*, and the *bolting assemblies* appear to be in the *snug-tightened condition*. Because *pretension* is not required for the proper performance of a *snug-tightened joint*, the installed bolts should not be inspected to determine the actual installed *pretension*. Likewise, the arbitration procedures described in Section 10 are not applicable.

9.2. Pretensioned Joints

For *pretensioned joints*, the following inspection shall be performed in addition to that required in Section 9.1:

- (1) When the *turn-of-nut method* is used for *pretensioning*, the inspection shall be in accordance with Section 9.2.1;
- (2) When the *calibrated wrench method* is used for *pretensioning*, the inspection shall be in accordance with Section 9.2.2;
- (3) When the *twist-off tension control bolt method* is used for *pretensioning*, the inspection shall be in accordance with Section 9.2.3;
- (4) When the *direct tension indicator method* is used for *pretensioning*, the inspection shall be in accordance with Section 9.2.4;

- (5) When the *combined method* is used for *pretensioning*, the inspection shall be in accordance with Section 9.2.5; and
- (6) When alternative-design *bolting components, assemblies*, or installation methods that meet the requirements of Section 2.12 are used, the inspection shall be in accordance with inspection instructions provided by the consensus standard or *Manufacturer* and approved by the *Engineer of Record*.

Commentary:

When *joints* are designated as *pretensioned*, they are not subject to the same *faying surface* inspection requirements as are specified for *slip-critical joints* in Section 9.3.

9.2.1. Turn-of-Nut Method Pretensioning

The *Inspector* shall:

- (1) Observe the pre-installation verification testing required in Section 7;
- (2) Verify by *routine observation* that the *snug-tight condition* has been achieved in accordance with Section 8.1; and
- (3) Verify by *routine observation* that the bolting crew subsequently rotates the turned element relative to the unturned element by the amount specified in Table 8.1. Alternatively, when *bolting assemblies* are match-marked after snug-tightening of the *joint* but prior to *pretensioning*, visual inspection after *pretensioning* is permitted in lieu of *routine observation*. No further evidence of conformity is required.

A *pretension* that is greater than the value specified in Table 5.2 shall not be cause for rejection. A rotation that exceeds the required values, including tolerance, specified in Table 8.1 shall not be cause for rejection.

Commentary:

Matchmarking of the assembly during installation as discussed in the Commentary to Section 8.2.1 improves the ability to inspect bolts that have been *pretensioned* with the *turn-of-nut method*. When impact tools are used the sides of nuts and bolt heads that have been impacted sufficiently to induce the minimum *pretension* in Table 5.2 will appear slightly peened.

Proper inspection of the *bolting assemblies pretensioned* with this method is for the *Inspector* to observe the required pre-installation verification testing of the *bolting assemblies* and the method to be used, followed by monitoring of the work in progress to verify that the method is routinely and properly applied, or visual inspection of match-marked assemblies.

Some problems with the *turn-of-nut method* have been encountered with galvanized or coated bolts. In some cases, the problems have been attributed to especially effective lubricants applied by the *Manufacturer* to ensure that bolts and nuts from stock will meet the ASTM Standard requirements for rotational

capacity of galvanized or coated *bolting assemblies*. Jobsite testing in a *bolt tension measurement device* demonstrated that the lubricant reduced the coefficient of friction between the bolt and nut to the degree that “the full effort of an ironworker using an ordinary spud wrench” to snug-tighten the *joint* actually induced the full required *pretension*. Well lubricated *high-strength bolts* may require significantly less torque to induce the specified *pretension*. The required pre-installation verification will reveal this.

Conversely, the absence of lubrication or lack of proper overlapping of galvanized or coated bolts can cause seizing of the nut and bolt threads, which will result in a twisting failure of the bolt at less than the specified *pretension*. For such situations, the use of a *bolt tension measurement device* to check the bolt assemblies to be installed will be helpful in establishing the need for lubrication.

9.2.2. *Calibrated Wrench Method Pretensioning*

The *Inspector* shall:

- (1) Observe the pre-installation verification testing required in Section 7;
- (2) Verify by *routine observation* that the *snug-tight condition* has been achieved in accordance with Section 8.1; and
- (3) Verify by *routine observation* that the bolting crew subsequently applies the calibrated wrench to the nut. No further evidence of conformity is required.

A *pretension* that is greater than the value specified in Table 5.2 shall not be cause for rejection. The use of a torque greater than the minimum installation torque shall not be cause for rejection.

Commentary:

For proper inspection of the method, it is necessary for the *Inspector* to observe the required pre-installation verification testing of the *bolting assemblies* and the method to be used, followed by monitoring of the work in progress to verify that the method is routinely and properly applied between removal from *protected storage* and final *pretensioning*.

9.2.3. *Twist-Off Tension Control Bolt Method Pretensioning*

The *Inspector* shall:

- (1) Observe the pre-installation verification testing required in Section 7;
- (2) Verify by *routine observation* that the *snug-tight condition* has been achieved in accordance with Section 8.1 and that splined ends are intact after snug-tightening; and
- (3) Verify by *routine observation* that the splined ends are subsequently twisted off during *pretensioning* by the bolting crew. No further evidence of conformity is required.

A *pretension* that is greater than the value specified in Table 5.2 shall not be cause for rejection.

Commentary:

The sheared-off splined end of an installed *twist-off tension control bolting assembly* merely signifies that, at some time, the bolt was subjected to a torque that was sufficient to cause the separation of the spline. If all *bolting assemblies* are individually *pretensioned* in a single continuous operation without first properly snug-tightening all *bolting assemblies*, relaxation of previously tightened bolts may occur, and this may give a misleading indication that the bolts have been properly *pretensioned*. Therefore, it is necessary that the *Inspector* verify by *routine observation* that the *snug-tight condition* has been achieved in the *joints* in accordance with Section 8.1. This is followed by monitoring of the work in progress to verify that the method is routinely and properly applied within the limits on time between removal from *protected storage* and final twist-off of the splined end.

9.2.4. *Direct Tension Indicator Method Pretensioning*

The *Inspector* shall:

- (1) Observe the pre-installation verification testing required in Section 7.
- (2) Verify by *routine observation* that the *snug-tight condition* has been achieved in accordance with Section 8.1, that the appropriate feeler gage is accepted in half or more of the spaces between the protrusions of the *direct tension indicator*, and that the protrusions are properly oriented away from the work. If the appropriate feeler gage is accepted in fewer than half of the spaces, the *direct tension indicator* shall be removed and replaced.
- (3) After *pretensioning*, verify by *routine observation* that the appropriate feeler gage is refused entry into more than half of the spaces between the protrusions. No further evidence of conformity is required.

A *pretension* that is greater than that specified in Table 5.2 or feeler gage refusal in all locations shall not be cause for rejection.

Commentary:

When the *joint* is initially snug-tightened, the *direct tension indicator* arch-like protrusions will generally compress partially. Whenever the snug-tightening operation causes one half or more of the gaps between these arch-like protrusions to close to less than the *job inspection gap*, the *direct tension indicator* must be replaced. Only after this initial operation should the bolts be *pretensioned* in a systematic manner. If the *bolting assemblies* are installed and *pretensioned* in a single continuous operation, *direct tension indicators* may give the *Inspector* a misleading indication that the *bolting assemblies* have been properly *pretensioned*. Therefore, it is necessary that the *Inspector* observe that the *snug-tight condition* has been achieved before this final *pretensioning*. Following this operation, the *Inspector* should monitor the work in progress to verify that the method is routinely and properly applied.

9.2.5 Combined Method Pretensioning

The *Inspector* shall:

- (1) Observe the pre-installation verification testing required in Section 7;
- (2) Verify by *routine observation* that the bolting crew applies to the nut the *initial torque* used in pre-installation verification testing, that the plies have been brought into *firm contact*, and that the requirements of Section 8.1 have been met; and
- (3) Verify by *routine observation* that the bolting crew properly rotates the turned element relative to the unturned element by the amount specified in Table 8.2. Alternatively, when *bolting assemblies* are match-marked after the initial application of the torque, but prior to *pretensioning*, visual inspection after *pretensioning* is permitted in lieu of *routine observation*. No further evidence of conformity is required.

A *pretension* that is greater than the value specified in Table 5.2 shall not be cause for rejection. A rotation that exceeds the required values, including tolerance, in Table 8.2, shall not be cause for rejection.

Commentary:

Matchmarking of the assembly during installation as discussed in the Commentary to Section 8.2.1 improves the ability to inspect *bolting assemblies* that have been *pretensioned* with the *combined method* of *pretensioning*. The sides of nuts and bolt heads that have been *pretensioned* using impact wrenches sufficiently to induce the minimum *pretension* in Table 5.2 may appear slightly peened.

Proper inspection of the *bolting assemblies* *pretensioned* with this method is for the *Inspector* to observe that the required *initial torque* is applied to the *bolting assemblies* in the *joint* and that the plies have been brought into *firm contact* before the prescribed rotation is applied to the turned element. Subsequently, the *Inspector* shall observe that the prescribed rotation was applied.

9.3. Slip-Critical Joints

Prior to assembly, it shall be visually verified that the *faying surfaces* of *slip-critical joints* meet the requirements in Section 3.2.2. Subsequently, the inspection required in Section 9.2 shall be performed.

Commentary:

When *joints* are specified as *slip-critical joints*, it is necessary to verify that the *faying surface* condition meets the requirements as specified in the contract documents prior to assembly of the *joint* and that the bolts are properly *pretensioned* after they have been installed. Accordingly, the inspection requirements for *slip-critical joints* are identical to those specified in Section 9.2, with additional *faying surface* condition inspection requirements.

SECTION 10. ARBITRATION

When it is suspected after inspection in accordance with Section 9.2 or Section 9.3 that bolts in *pretensioned* or *slip-critical joints* do not have the proper *pretension*, the following arbitration procedure is permitted.

- (1) A representative sample of five bolt and nut assemblies of each combination of diameter, length, grade and *lot* in question shall be installed in a *bolt tension measurement device*. The material under the turned element shall be the same as in the actual installation—that is, structural steel or hardened washer. The bolt shall be partially tightened to approximately 15 percent of the *pretension* specified in Table 5.2. Subsequently, the bolt shall be *pretensioned* to the minimum value specified in Table 5.2.
- (2) A torque wrench that indicates torque by means of a readout, or one that may be adjusted to give an indication that a defined torque has been reached, shall be applied to the *pretensioned* bolt. The torque that is necessary to rotate the nut or bolt head five degrees (approximately 1 in. at 12-in. radius) relative to its mating component in the tightening direction shall be determined.
- (3) The *arbitration torque* shall be determined by rejecting the high and low values and averaging the remaining three.
- (4) Bolts represented by the above sample shall be tested by applying the *arbitration torque* in the tightening direction to 10 percent of the *bolting assemblies*, but no fewer than two *bolting assemblies*, selected at random in each *joint* in dispute. If no nut or bolt head is turned relative to its mating component by the application of the *arbitration torque*, the *joint* shall be accepted as properly *pretensioned*.

If verification of bolt *pretension* is required after the passage of a period of time and exposure of the completed *joints*, an alternative arbitration procedure that is appropriate to the specific situation shall be used.

If any nut or bolt is turned relative to its mating component by an attempted application of the *arbitration torque*, all bolts in the *joint* shall be tested. Those bolts whose nut or head is turned relative to its mating component by the application of the *arbitration torque* shall be *re-pretensioned* by the *Fabricator* or *Erector* and reinspected. Alternatively, the *Fabricator* or *Erector*, at his/her option, is permitted to *re-pretension* all of the bolts in the *joint* and subsequently resubmit the *joint* for inspection.

Commentary:

When bolt *pretension* is arbitrated using torque wrenches after *pretensioning*, such arbitration is subject to all of the uncertainties of torque-controlled *calibrated wrench method* installation that are discussed in the Commentary to Section 8.3.2. Additionally, the reliability of after-the-fact torque wrench arbitration is reduced by the absence of many of the controls that are necessary to minimize the variability of the torque-to-*pretension* relationship, such as:

- (1) The use of hardened washers²;
- (2) Careful attention to lubrication; and
- (3) The uncertainty of the effect of passage of time and exposure in the installed condition.

Furthermore, in many cases such arbitration may have to be based upon an *arbitration torque* that is determined either using bolts that can only be assumed to be representative of the bolts used in the actual job or using bolts that are removed from completed *joints*. Ultimately, such arbitration may wrongly reject *bolting assemblies* that were subjected to a properly implemented installation procedure or accept *bolting assemblies* that were not properly installed. The arbitration procedure contained in this Specification is provided, in spite of its limitations, as the most feasible available at this time.

Arbitration using an ultrasonic extensometer or a mechanical one capable of measuring changes in bolt length can be performed on a sample of *bolting assemblies* that is representative of those that have been installed in the work. Several manufacturers produce equipment specifically for this application. The use of appropriate techniques, which includes calibration, can produce a very accurate measurement of the actual *pretension*. The method involves measurement of the change in bolt length during the release of the nut, combined with either a load calibration of the removed *bolting assembly* or a theoretical calculation of the force corresponding to the measured elastic release or “stretch.” Reinstallation of the released *bolting assembly* or installation of a replacement *bolting assembly* is required.

The required release suggests that the direct use of extensometers as an inspection tool be used in only the most critical cases. The problem of reinstallation may require *bolting assembly* replacement unless torque can be applied slowly using a manual or hydraulic wrench, which will permit the restoration of the original elongation.

² For example, because the reliability of the turn-of-nut method is not dependent upon the presence or absence of washers under the turned element, washers are not generally required, except for other reasons as indicated in Section 6. Thus, in the absence of washers, after-the-fact, torque-based arbitration is particularly unreliable when the turn-of-nut method has been used for installation.

APPENDIX A. TESTING METHOD TO DETERMINE THE SLIP COEFFICIENT FOR COATINGS USED IN BOLTED JOINTS

SECTION A1. GENERAL PROVISIONS

A1.1. Purpose and Scope

The purpose of this testing procedure is to determine the *mean slip coefficient* of a coating for use in the design of *slip-critical joints*. The *mean slip coefficient* is determined upon successful completion of both short-term compression tests and long-term tension creep tests.

Commentary:

The Research Council on Structural Connections first approved the testing method developed by Yura and Frank (1985) that tested bare steel *faying surfaces* with adherent mill scale, blast cleaned bare steel *faying surfaces*, and blast cleaned *faying surfaces* with liquid applied coatings. It has since been revised to incorporate changes resulting from the intervening years of experience with the testing method, and is included as an appendix to this Specification.

Testing programs using the methods in this Appendix have already assessed the mean slip resistance of clean mill scale, blast cleaned bare steel, and hot-dip galvanized *faying surfaces*. This Appendix presents a generic test method for assessing coatings or combinations of coatings other than these three universally adopted.

It is noted that this Appendix describes a method to determine the certification of a slip coefficient of a *faying surface* or coating and does not address how that certification should be applied. Coating reducer, percent coating reduction, coating dry film thickness, *cure* time, temperature, relative humidity, and *degree of cure* are variables measured during testing. Satisfactory *degree of cure* can be achieved using a reducer, percent reduction, *cure* time, temperature, and relative humidity other than those recorded at time of test as long as they are within the coating manufacturer's recommendations. *Degree of cure* may be evaluated using one or more of the following: Sclerometer Hardness (ISO 4586-2), Pencil Hardness (ASTM D3363), MEK Double Rub Test (ASTM D4752), and/or by other means as recommended by the coating manufacturer. Coating dry film thickness and *degree of cure* are essential variables as recorded on the certification.

A1.2. Definition of Essential Variables

Essential variables are those that, if changed, will require retesting of the coating to determine its *mean slip coefficient*. The essential variables and the relationship of these variables to the limitations of application of the coating for structural *joints* are given below. The slip coefficient testing shall be repeated if there is any change in these essential variables.

- A1.2.1. *Degree of Cure*: *Degree of cure* is an essential variable. *Cure* shall be performed according to published coating manufacturer's recommendations. The *degree of cure* of the coating shall be evaluated using one or more of the following: (a) Sclerometer Hardness, (b) Pencil Hardness, (c) MEK Double Rub Test, or (d) by other means as recommended by the coating manufacturer. Each evaluation method recommended by the coating manufacturer shall be performed at the time of test and shall be recorded on the certification.
- A1.2.2. *Coating Thickness*: The coating thickness is an essential variable. The maximum average coating thickness, as per SSPC PA2, allowed on the *faying surfaces* is 2 mils less than the average thickness, rounded to the nearest whole mil, of the coating that is used on the test specimens.
- A1.2.3. *Coating Composition and Method of Manufacture*: The composition of the coating and its method of manufacture are essential variables.

A1.3. Retesting

A coating that fails to meet the creep requirements in Section A4 may be retested in accordance with methods in Section A4 at a lower slip coefficient without repeating the static short-term tests specified in Section A3. Essential variables shall remain unchanged in the retest.

A1.4. Duration of Coating Slip Certificate

Any coating slip certificate issued under this Appendix for a coating is valid for a term of 84 months after the certificate has been issued. After 84 months, the coating shall be fully retested according to this Appendix and reissued a new certificate.

SECTION A2. TEST PLATES AND COATING OF THE SPECIMENS

A2.1. Test Plates

The test specimen plates for the short-term static tests are shown in Figure A-1. The plates are 4 in. \times 4 in. \times $\frac{5}{8}$ in. thick, with a 1-in.-diameter hole drilled $1\frac{1}{2}$ in. \pm $\frac{1}{16}$ in. from one edge. The test specimen plates for the creep tests are shown in Figure A-2. The plates are 4 in. \times 7 in. \times $\frac{5}{8}$ in. thick with two 1-in.-diameter holes drilled $1\frac{1}{2}$ in. \pm $\frac{1}{16}$ in. from each end. The edges of the plates may be milled, as-rolled, or saw-cut; thermally cut edges are not permitted. The contact surfaces shall be flat enough to ensure that they will be in reasonably full contact over the *faying surface*. All burrs, lips, or rough edges shall be removed. The arrangement of the specimen plates for the testing is shown in Figure A-2. The plates shall be fabricated from a steel with a specified minimum yield strength that is between 36 and 50 ksi.

If specimens with more than one bolt are desired, the contact surface per bolt shall be 4 in. \times 3 in. as shown for the single-bolt specimen in Figure A-1.

Commentary:

The use of 1-in.-diameter bolt holes in the specimens is to ensure that adequate clearance is available for slip. Fabrication tolerances, coating buildup on the holes, and assembly tolerances tend to reduce the apparent clearances.

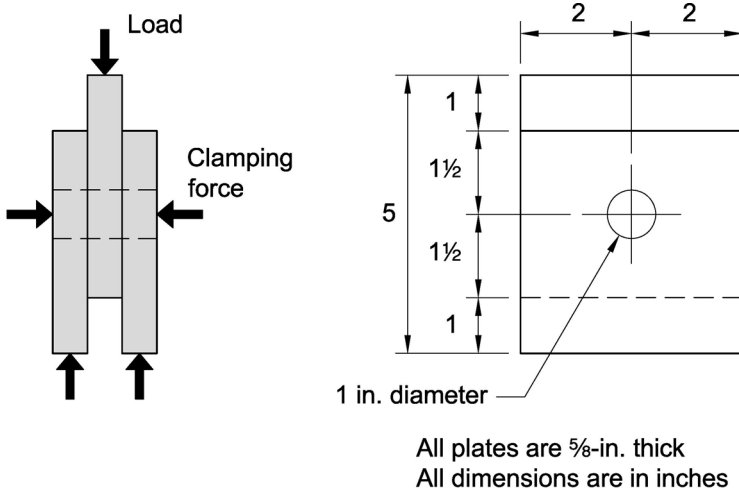

Figure A-1. Compression slip test specimen.

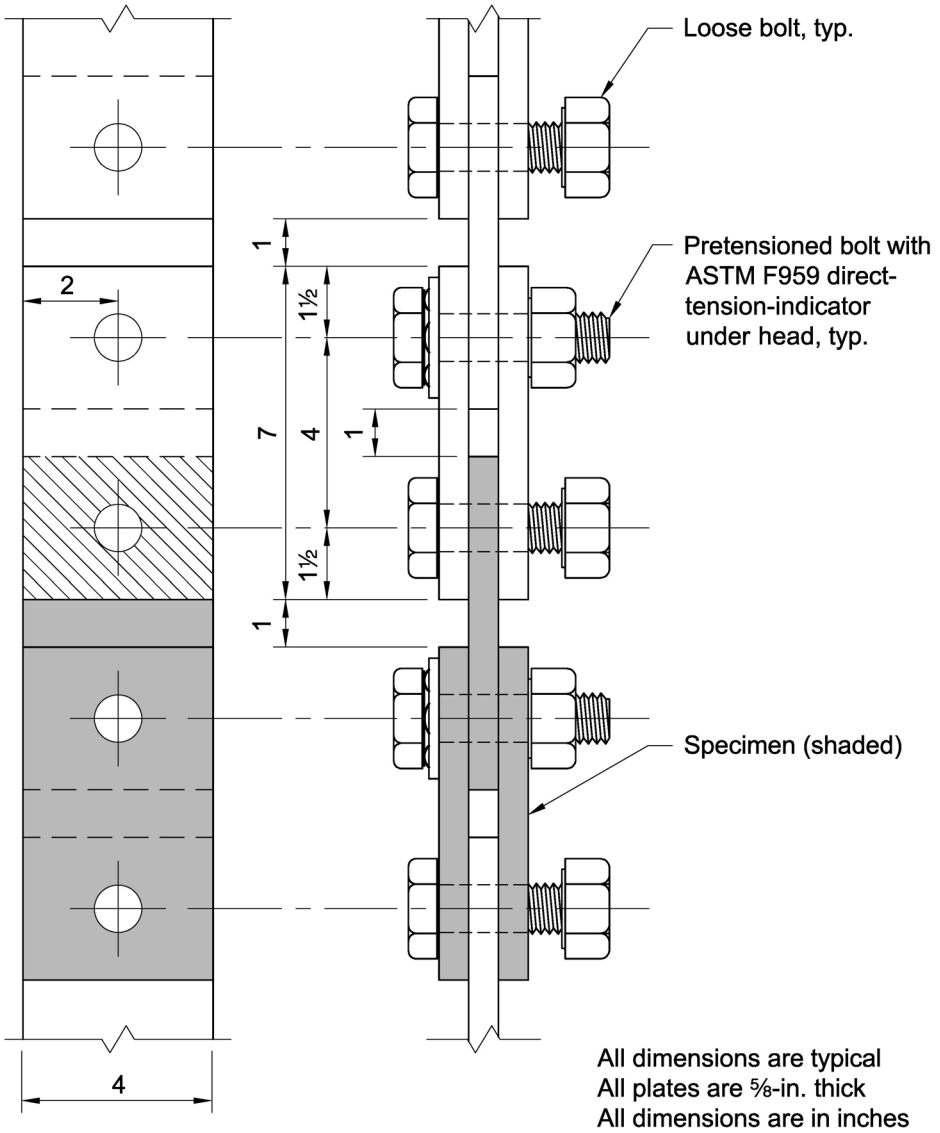

Figure A-2. Creep test specimen assembly.

A2.2. Specimen Coating

Coatings are to be applied to the specimens in a manner that is consistent with that to be used in the actual intended structural application. The method of applying the coating and the surface preparation shall be given in the test report. The specimens are to be coated to an average thickness that is 2 mils greater than the maximum thickness to be used in the structure on both of the plate surfaces (the *faying* and outer surfaces). The thickness of the total coating and the primer, if used, shall be measured on the contact surface of the specimens. The thickness shall be measured in accordance with SSPC-PA2. Two spot readings (six gage readings) shall be made for each contact surface. The overall average thickness from the three plates comprising a specimen is the average thickness for the specimen. This value shall be reported for each specimen. The average coating thickness of the creep specimens shall be calculated and reported.

The time between application of the coating and specimen assembly shall be the same for all specimens within ± 4 hours. The average time shall be calculated and reported.

SECTION A3. SHORT-TERM COMPRESSION SLIP TESTS

The methods and procedures described herein are used to experimentally determine the *mean slip coefficient* under short-term static loading for *slip-critical joints*. The *mean slip coefficient* shall be determined by testing one set of five specimens and then verified for long-term tension creep loading covered in Section A4.

Commentary:

The proposed test method is designed to provide the necessary information to evaluate the suitability of a coating for *slip-critical joints* and to determine the *mean slip coefficient* to be used in the design of the *joints*. The initial testing of the short-term compression specimens provides a measure of the scatter of the slip coefficient. The slip coefficient under short-term static loading has been found to be independent of the magnitude of the clamping force, normal variation in applied coating thickness, and bolt hole diameter.

A3.1. Compression Test Setup

The test setup shown in Figure A-3 has two major loading components, one to apply a clamping force to the specimen plates and another to apply a compressive load to the specimen so that the load is transferred across the *faying surfaces* by friction.

Commentary:

The slip coefficient can be easily determined using the hydraulic bolt test setup included in this Specification. The clamping force system simulates the clamping action of a *pretensioned high-strength bolt* through a controlled and directly measurable way.

A3.1.1. Clamping Force System: The clamping force system consists of a $\frac{7}{8}$ -in.-diameter threaded rod that passes through the specimen and a centerhole compression ram. An ASTM A563 Grade DH nut is used at both ends of the rod and a hardened washer is used at each side of the test specimen. Between the ram and the specimen is a specially modified $\frac{7}{8}$ -in.-diameter ASTM A563 Grade DH nut in which the threads have been drilled out so that it will slide with little resistance along the rod. When oil is pumped into the centerhole ram, the piston rod extends, thus forcing the special nut against one of the outside plates of the specimen. This action puts tension in the threaded rod and applies a clamping force to the specimen, thereby simulating the effect of a *pretensioned bolt*. If the diameter of the centerhole ram is greater than 1 in., additional plate washers will be necessary at the ends of the ram. The clamping force system shall have a capability to apply a load of at least 49 kips.

Commentary:

The loading rod should be made of steel with a strength greater than or equal to an ASTM F3125 Grade A490 bolt. Understrength rods may fracture under loading causing flying debris that could injure test operators and it is recommended to proof test the rod to 55 kips before use in testing. Testing agencies should consider regular replacement of the loading rod.

- A3.1.2. **Compressive Load System:** A compressive load shall be applied to the specimen until slip occurs. This compressive load shall be applied with a compression test machine or a reaction frame using a hydraulic loading device. The loading device and the necessary supporting elements shall be able to support a force of 120 kips.
- A3.1.3. **Load Train Alignment:** The testing agency shall ensure that the loading system is constructed such that the lines of action from the spherical head and the centerhole ram intersect at the theoretical center of the three test plates. A tolerance of $\pm\frac{1}{8}$ in. is considered allowable in any direction. This alignment shall be checked every time a new specimen is installed.

A3.2. Instrumentation

- A3.2.1. **Clamping Force:** The clamping force may be measured by pressure in the ram or placing a load cell in series with the ram. The device measuring clamping load shall be calibrated annually and be accurate within ± 0.5 kip.
- A3.2.2. **Compression Load:** The compression load shall be measured during the test by direct reading from a compression testing machine, a load cell in series with the specimen, and the compression loading device or pressure readings on a calibrated compression ram. The device measuring compression load shall be calibrated annually and be accurate within ± 1.0 kip.

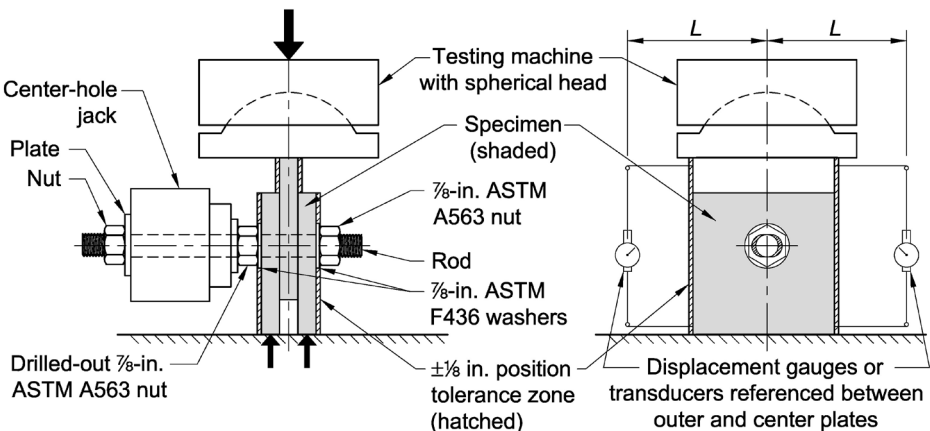

Figure A-3. Compression slip test setup.

- A3.2.3. Slip Deformation: The displacement of the center plate relative to the two outside plates shall be measured. This displacement, called “slip” for simplicity, shall be the average of the displacement gauges on each side of the specimen. Deflections shall be measured by dial gauges or any other calibrated device that has a resolution of at least 0.001 in. and shall be calibrated annually.

Commentary:

The preferred method of measuring the relative displacement is by referencing the displacement measurement between the plates directly, and not between the loading platens. Referencing the displacement between the loading platens may result in a load versus slip displacement response with a low initial stiffness due to seating of the specimen into the loading platens, more so than can be overcome by the 5-kip offset described in Section A3.3. The low stiffness may erroneously affect determination of the slip load described in Section A3.4. More details about the initial displacement response and means to mount displacement gauges can be found in Ocel et al. (2014).

A3.3. Test Procedure

The specimen shall be installed in the test setup as shown in Figure A-3. Before the hydraulic clamping force is applied, the individual plates shall be positioned so that they are in, or close to, full bearing contact with the $\frac{7}{8}$ -in. threaded rod in a direction that is opposite to the planned compressive loading to ensure obvious slip deformation. Care shall be taken in positioning the two outside plates so that the specimen is perpendicular to the base with both plates in contact with the base. After the plates are positioned, the centerhole ram shall be engaged to produce a clamping force of 49 kips. The applied clamping force shall be maintained within ± 0.5 kip during the test until slip occurs.

The spherical head of the compression loading machine shall be brought into contact with the center plate of the specimen after the clamping force is applied. The spherical head or other appropriate device ensures concentric loading. In order to eliminate seating displacement of the specimens, the displacement gauges shall be engaged, attached, or zeroed at a compressive load of 5.0 kips.

When the slip gauges are in place, the compression load shall be applied at a rate that does not exceed 25 kips per minute nor 0.003 in. of slip displacement per minute until the slip load is reached. It is the intent of these limits to provide a test that will take approximately 5 minutes to attain the failure load. The test shall be terminated when a slip of 0.04 in. or greater is recorded. The load-slip relationship shall be continuously recorded in a manner sufficient to evaluate the slip load defined in Section A3.4.

Commentary:

It is helpful to use a temporary support beneath the center plate before application of the clamping load to maximize the amount of slip before the plates go into bearing on the loading rod once clamped.

A3.4. Slip Load

Typical load-slip response is shown in Figure A-4. Three types of curves are usually observed and the slip load associated with each type is defined as follows:

Curve (a) Slip load is the maximum load, provided this maximum occurs before a slip of 0.02 in. is recorded.

Curve (b) Slip load is the load at which the slip rate increases suddenly.

Curve (c) Slip load is the load corresponding to a deformation of 0.02 in. This definition applies when the load versus slip curves show a gradual change in response.

A3.5. Slip Coefficient

The slip coefficient for an individual specimen k_s shall be calculated as follows:

$$k_s = \frac{\text{Slip load}}{2 \times \text{Clamping force}} \quad (\text{Equation A3.1})$$

The *mean slip coefficient*, μ , for one set of five specimens shall be calculated as the average of the five samples. Alternatively, in case the result of one of the samples is substantially lower than the average of the other four, the *mean slip coefficient* may be calculated as the average of four samples provided the lowest attained value passes the following criteria:

$$\frac{\mu - k_{s_{\min.}}}{\sigma} \geq 1.71 \quad (\text{Equation A3.2})$$

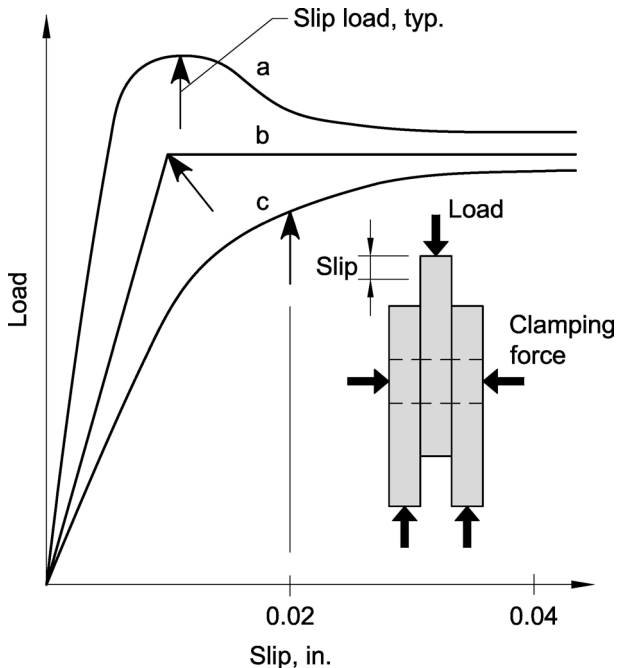

Figure A-4. Definition of slip load.

where

- μ = the average of the five k_s values attained
- σ = the standard deviation of the five k_s values attained
- $k_{s,min.}$ = lowest k_s value in five samples

Commentary:

The criterion for the outlier analysis can only detect a single outlier based on the work of Grubbs (1950). The threshold value of 1.71 is based on a sample size of five with a critical value of 5 percent based on a two-tailed Student’s T-distribution. This effectively means the outlier passing the criterion in Equation A3.2 falls outside the 95 percent confidence limits of an assumed normal distribution. Grubb’s test is only valid for the removal of one outlier, and rejection of more than one outlier is not used since the compression test method only relies on five replicates to begin with. If the testing agent feels there may be two or more outliers, it is recommended to run a new series of five tests. Additionally, for sample populations with small scatter (i.e., coefficient of variation < 1%), the outlier criterion may identify good data as an outlier, and some discretion must be used on whether it is appropriate to screen for an outlier.

To demonstrate the outlier analysis, consider the slip curves attained in testing five replicates of a liquid applied coating shown in Figure C-A-1. Test 2 is a suspected outlier and using Equation A3.2 determines that $0.44 - 0.34/0.058 = 1.72$ is greater than 1.71; therefore, it may be disregarded as an outlier. And, thus, the reported *mean slip coefficient* would be the average of the remaining four results, or 0.46.

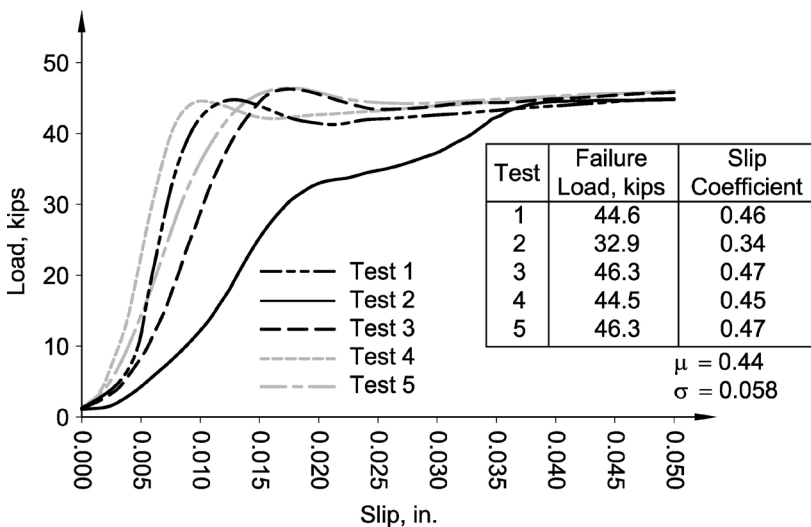

Figure C-A.1. Example load versus slip plots.

The testing agent should also be aware of the information that can be gleaned from plots of load versus slip. In the plot shown in Figure C-A.1, “Test 2” has a double plateau response, which is characteristic of a specimen that is not seated correctly—that is, only one of the two outer plates was initially in contact with the platen. Additionally, it is possible to distinguish if slip is occurring or if the plates are bearing on the loading rod. Figure C-A.2 shows a response of a slip test where load continuously increases as slip is occurring. Such a response is typical when bearing has interfered with free slip. If such a response is unique among the five tested specimens, the test should be eliminated when determining the *mean slip coefficient*.

A3.6. Alternative Test Methods

Alternative test methods to determine slip are permitted, provided the accuracy of load measurement and clamping satisfies the conditions presented in the previous sections. For example, the slip load may be determined from a tension-type test setup rather than the compression-type test setup as long as the contact surface area per bolt of the test specimen is the same as that shown in Figure A-1. The clamping force of at least 49 kips may be applied by any means, provided the force can be accurately established within ± 0.5 kip.

Commentary:

Alternative test procedures and specimens may be used as long as the accuracy of load measurement and specimen geometry are maintained as prescribed. For example, strain-gauged bolts can usually provide the desired accuracy. However, bolts that are *pretensioned* by the *turn-of-nut method*, *calibrated wrench method*, alternative-design *bolting assembly*, or *direct tension indicator method* usually show too much variation to meet the ± 0.5 kip accuracy of the slip test.

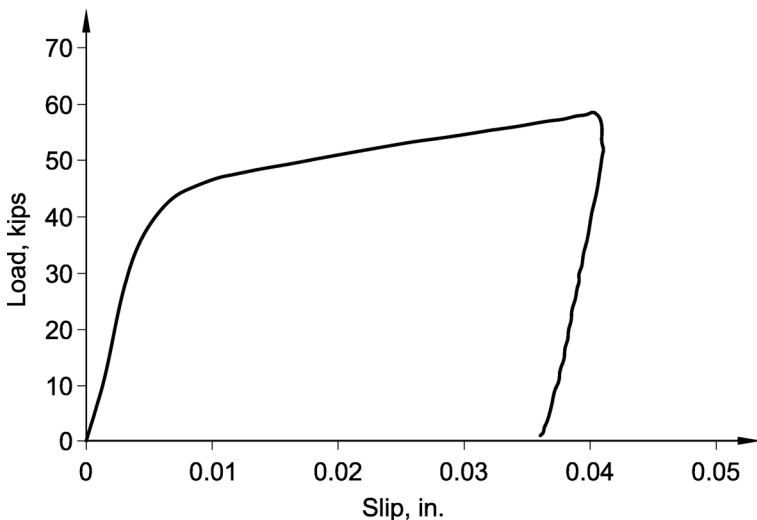

Figure C-A.2. Example load versus slip curve bearing on loading rod.

SECTION A4. TENSION CREEP TEST

The test method outlined is intended to ensure that the coating will not undergo significant creep deformation under sustained service loading. The test also indicates the loss in clamping force in the bolt due to the compression or creep of the coating. Three replicate specimens are to be tested. Adherence to this testing method provides that the creep deformation of the coating due to both the clamping force of the bolt and the service-load *joint* shear are such that the coating will provide satisfactory performance under sustained loading.

Commentary:

Tests of bolted specimens revealed that the clamping force may not be constant but decreases with time due to the compressive creep of the coating on the *faying surfaces* and under the nut and bolt head. Thicker coatings tend to creep more than thinner coatings.

The reduction in clamping force can be considerable for *joints* with high clamping force and thick coatings (as much as a 20 percent loss). This reduction in clamping force causes a corresponding reduction in the slip load. The resulting reduction in slip load must be considered in the overall test procedure. The loss in clamping force is a characteristic of the coating. Consequently, it cannot be accounted for by an increase in the factor of safety or a reduction in the clamping force used for design without unduly penalizing coatings that do not exhibit this behavior.

A4.1. Test Setup

Tension-type specimens, as shown in Figure A-2, shall be used. The replicate specimens shall be linked together in a single chain-like arrangement, using loose pin bolts, so the same load is applied to all specimens. The specimens shall be assembled so the specimen plates are bearing against the bolt in a direction opposite to the applied tension loading. Care shall be taken in the assembly of the specimens to ensure the centerline of the holes used to accept the pin bolts is in line with the bolts used to assemble the *joint*. The load level, specified in Section A4.2, shall be maintained constant within ± 1 percent by springs, load maintainers, servo controllers, dead weight, or other suitable equipment. The bolts used to clamp the specimens together shall be $\frac{7}{8}$ -in. diameter ASTM F3125 Grade A490 bolts. All bolts shall come from the same *lot*.

The clamping force in the bolts shall be a minimum of 49 kips. The clamping force shall be determined by calibrating the bolt force with bolt elongation, if standard bolts are used. Alternatively, special *bolting assemblies* that control the clamping force by other means, such as calibrated bolt torque, strain gauges, or direct tension indicating washers are permitted. A minimum of three bolt calibrations shall be performed using the technique selected for bolt force determination. The average of the three-bolt calibration shall be calculated and reported. The method of measuring bolt force shall ensure the clamping force is within ± 2 kips of the average value.

The relative slip between the outside plates and the center plates shall be measured to an accuracy of 0.001 in. These slips are to be measured on both sides of each specimen.

A4.2. Test Procedure

The load placed on the creep specimen is as follows:

$$R_s = \frac{2\mu_t T_t}{1.5} \quad (\text{Equation A4.1})$$

where

μ_t = mean slip coefficient for the particular slip coefficient category under consideration

T_t = average clamping force from the three-bolt calibrations ≥ 49 kips

The load shall be placed on the specimen and held for 1,000 hours. The creep deformation of a specimen is calculated using the average reading of the two displacements on either side of the specimen. The difference between the average after 1,000 hours and the initial average reading taken within one-half hour after loading the specimens is defined as the creep deformation of the specimen. This value shall be reported for each specimen. If the creep deformation of any specimen exceeds 0.005 in., the coating has failed the test for the slip coefficient used. The coating may be retested using new specimens in accordance with this Section at a load corresponding to a lower value of slip coefficient.

Commentary:

The mean slip coefficient, μ_t , used to determine the creep test load shall be the slip coefficient corresponding to the design classification or, in the case of coating specific slip coefficient, the average of the short-term slip tests.

Rate of creep deformation increases as the applied load approaches the slip load. Extensive testing has shown that the rate of creep is not constant with time; rather, it decreases with time. After about 1,000 hours of loading, the additional creep deformation is negligible.

REFERENCES

- Allan, R.N. (1967), "The Effect of Oversize and Slotted Holes on the Behavior of a Bolted Joint," Thesis and Dissertation, Lehigh University, Bethlehem, PA.
- Allan, R.N. and Fisher, J.W. (1968), "Bolted Joints with Oversize or Slotted Holes," *Journal of the Structural Division*, Vol. 94, No. ST9, September, ASCE, Reston, VA.
- AASHTO. (2017). *AASHTO LRFD Bridge Design Specifications* (8th ed.). Washington, DC: American Association of State Highway and Transportation Officials.
- American Institute of Steel Construction, (2010). *Specification for Structural Steel Buildings*, AISC, Chicago, IL.
- American Institute of Steel Construction, (2016), *Specification for Structural Steel Buildings*, AISC, Chicago, IL.
- Birkemoe, P.C. and Herrschaft, D.C. (1970), "Bolted Galvanized Bridges—Engineering Acceptance Near," *Civil Engineering*, April, ASCE, Reston, VA.
- Borello, D., Denavit, M., and Hajjar, J. (2009) "Behavior of Bolted Steel Slip Critical Connections with Fillers," UIUC, Champaign, IL.
- Bowman, M. and Betancourt, M. (1991), "Reuse of A325 and A490 High-Strength Bolts," *Engineering Journal*, Vol 28, No. 3 (3rd Qtr.), AISC, Chicago, IL.
- Brahimi, S. (2006), "Qualification of Dacromet for Use with ASTM A490 High-Strength Structural Bolts—An Investigation per IFI-144," ASTM Committee F16 on Fasteners, IBECA Technologies Research Report.
- Brahimi, S. (2011), "Qualification of ASTM F2833 Coatings for Use on ASTM A490 High Strength Structural Bolts," ASTM Committee F16 on Fasteners, IBECA Technologies Research Report.
- Brahimi, S. (2014), "Qualification of ASTM F1136 Non-chrome (GEOMET 321 for Use with ASTM A490 High-Strength Structural Bolts—An Investigation per IFI-144," ASTM Committee F16 on Fasteners, IBECA Technologies Research Report.
- Brahimi, S. (2017), "Qualification of F3019/F3019M Coatings DELTA PROTEKT®KL 105 for Use on ASTM A490 High Strength Structural Bolts," ASTM Committee F16 on Fasteners, IBECA Technologies Research Report.
- Carter, C.J. (1996), "Specifying Bolt Length for High-Strength Bolts," *Engineering Journal*, Vol. 33, No. 2 (2nd Qtr.), AISC, Chicago, IL.
- Carter, C.J., Tide, R.H.R., and Yura, J.A. (1997), "A Summary of Changes and Derivation of LRFD Bolt Design Provisions," *Engineering Journal*, Vol. 34, No. 3 (3rd Qtr.), AISC, Chicago, IL.
- Chesson, Jr., E., Faustino, N.L., and Munse, W.H. (1964), "Static Strength of High-Strength Bolt under Combined Tension and Shear," SRS No. 288, UIUC Urbana, IL.

- Chesson, Jr., E., Faustino, N.L., and Munse, W.H. (1965), "High-Strength Bolts Subjected to Tension and Shear," *Journal of the Structural Division*, Vol. 91, No. ST5, October, ASCE, Reston, VA.
- Donahue, S., Helwig, T., and Yura, J. (2014), "Final Report for Study: Slip Coefficients for Galvanized Surfaces," University of Texas at Austin, Austin, TX.
- Fisher, J.W. and Beedle, L.S. (1964), "High Strength Bolting in the USA," IABSE Congress Report.
- Fisher, J.W. and Rumpf, J.L. (1965), "Analysis of Bolted Butt Joints," *Journal of the Structural Division*, Vol. 91, No. ST5, October, ASCE, Reston, VA.
- Frank, K.H. and Yura, J.A. (1981), "An Experimental Study of Bolted Shear Connections," FHWA/RD-81/148, December, Federal Highway Administration, Washington, D.C.
- Grondin, G., Jin, M., and Josi, G. (2007), *Slip-Critical Bolted Connections—A Reliability Analysis for the Design at Ultimate Limit State*, Preliminary Report prepared for the American Institute of Steel Construction, University of Alberta, Edmonton, Alberta, Canada.
- Grubbs, F.E. (1950), "Sample Criteria for Testing Outlying Observations," *The Annals of Mathematical Statistics*, Vol. 21, No. 1, pp. 27–28, doi: 10.1214/aoms/1177729885.
- Hamel S. and White S. (2016), *Thermo-Mechanical Modeling and Testing of Thermal Breaks in Structural Steel Point Transmittances*, Research Report for the American Institute of Steel Construction, University of Alaska Anchorage, AK.
- Hoyer, W. (1960) *Über Gleitfeste Schraubenverbindungen (3 Bericht) Hochfeste Schrauben mit Verschiedenem Lochspiel (On Slideproof Bolted Connections (3rd Report) High-Strength Bolts with Different Hole Clearance*, (3rd report), *Wissenschaftliches Zeitschrift der Hochschule fuer Bauwesen, Cottbus*, 1959/1960, Vol. 1, Cottbus, Germany.
- ISO: International Organization for Standardization, ISO 4586-2:2018, High-pressure decorative laminates (HPL, HPDL)—Sheets based on thermosetting resins (usually called laminates)—Part 2: Determination of properties.
- Kulak, G.L. and Birkemoe, P.C. (1993), "Field Studies of Bolt Pretension," *Journal of Constructional Steel Research*, No. 25, pp. 95–106.
- Kulak, G.L., Fisher, J.W., and Struik, J.H.A. (1987), *Guide to Design Criteria for Bolted and Riveted Joints*, (2nd ed.), John Wiley & Sons, New York, NY.
- Kulak, G.L. and Undershute, S.T. (1998), "Tension Control Bolts: Strength and Installation," *Journal of Bridge Engineering*, Vol. 3, No. 1, February, ASCE, Reston, VA.
- McKinney, M. and Zwerneman, F.J. (1993), "The Effect of Burrs on the Slip Capacity in Multiple Bolt Connections," *Final Report to the Research Council on Structural Connections*, August.
- Moore, A.M., Rassati, G.A., and Swanson, J.A. (2008), *Evaluation of the Current Resistance Factors for High-Strength Bolts*, Research Report to the Research Council on Structural Connections, Chicago, IL.

- Munse, W.H. (1967), "Structural Behavior of Hot Galvanized Bolted Connections," *Proceedings of the 8th International Conference on Hot-Dip Galvanizing*, June, London, England.
- Ocel, J., Kogler, R., and Ali, M. (2014), *Interlaboratory Variability of Slip Coefficient Testing for Bridge Coatings*, FHWA-HRT-14-093, Federal Highway Administration, McLean, VA.
- Peterman, K.D., Kordas, J., Moradei, J., Coleman, K., Hajjar, J.F., D'Aloisio, J.A., Webster, M.D., and Der Ananian, J. (2017), *Thermal Break Strategies for Cladding Systems in Building Structures*, Research Report to the Charles Pankow Foundation, Vancouver, WA.
- Peterman, K.D., Webster, M.D., D'Aloisio, J.A., and Hajjar, J.F., (2020), "Structural Performance of Steel Shelf Angles with Thermally-Improved Detailing" *ASCE Journal of Structural Engineering*.
- Polyzois, D. and Frank, K.H. (1986), "Effect of Overspray and Incomplete Masking of Faying Surfaces on the Slip Resistance of Bolted Connections," *Engineering Journal*, Vol. 23, No. 2 (2nd Qtr.), AISC, Chicago, IL.
- Polyzois, D. and Yura, J.A. (1985), "Effect of Burrs on Bolted Friction Connections," *Engineering Journal*, Vol. 22, No. 3 (3rd Qtr.), AISC, Chicago, IL.
- Roenker, A., Rassati G.A., and Swanson J.A. (2017) "Testing of Torque-and-Angle High-Strength Fasteners," University of Cincinnati, Cincinnati, OH.
- Schnupp, K.O. and Murray, T.M. (2003), "Effects of Head Size on the Performance of Twist-Off Bolts," Virginia Polytechnic Institute and State University, CC/VTI-ST 03/09, July 2003.
- Sherman, D.R. and Yura, J.A. (1998), "Bolted Double-Angle Compression Members," *Journal of Constructional Steel Research*, Vol. 47, pp. 1–3, Paper No. 197, Elsevier Science Ltd., Kidlington, Oxford, UK.
- Swanson J.A., Rassati G.A., and Larson, C.M. (2020a), "Dimensional Tolerance and Length Determination of High-Strength Bolts," *Engineering Journal*, Vol. 57, No. 1 (1st Qtr.), AISC, Chicago, IL.
- Swanson J.A., Rassati G.A., and Larson C.M. (2020b), "Reliability Study of Joints with Bolts Designed as X but Installed as N," *Engineering Journal*, Vol. 57, No. 1 (1st Qtr.), AISC, Chicago, IL.
- Tan, W., Maleev, V.V., and Birkemoe, P.C. (2005), "Installation Characteristics of ASTM F1852 Twist-Off Type Tension Control Structural Bolt/Nut/Washer Assemblies," Final Report Phase 1, June 2005, University of Toronto.
- Taylor, A.T., Rassati, G.A., and Swanson, J.A. (2008), *Evaluation of the Resistance Factors for Fully Threaded High Strength Fasteners*, Research Report to the Metal Building Manufacturers Association, Cleveland, OH.
- Tide, R.H.R. (2010), "Bolt Shear Design Considerations," *Engineering Journal*, Vol. 47, No. 1 (1st Qtr.), AISC, Chicago, IL.

- Yura, J.A. and Frank, K.H. (1985), "Testing Method to Determine Slip Coefficient for Coatings Used in Bolted Joints," *Engineering Journal*, Vol. 22, No. 3 (3rd Qtr.), AISC, Chicago, IL.
- Yura, J.A., Frank, K.H., and Cayes, L. (1981), "Bolted Friction Connections with Weathering Steel," *Journal of the Structural Division*, Vol. 107, No. ST11, November, ASCE, Reston, VA.

INDEX

Alternative-design bolting components, assemblies, and methods	30
Arbitration	75
Bearing strength	42
Bolt holes	
Bearing strength at	42
Bolt pretensioning	61
Calibrated wrench pretensioning	64
Direct tension indicator pretensioning	66
Turn-of-nut pretensioning	62
Twist-off tension control bolt pretensioning	66
Combined method pretensioning	68
Bolted joints, limit states in	37
Bolted parts	23
Bolts	
Alternative-design	20
Geometry	10
Heavy hex structural	8
Reuse	19
Specifications	8, 9
Spline end twist-off matched bolting bolt assemblies	9
Spline end fixed matched bolting assemblies	9
Bolt tension measurement device	54, 58, 67
Burrs	31
Calibrated wrench pretensioning	
Inspection of	72
Installation using	64
Use of washers in	49
Coatings	
Bolting components	14
On faying surfaces	24
Testing method to determine the slip coefficient for	77
Combined shear and tension	41
Combined method	56, 68, 74

Components, bolting	6
Connected plies	23
Design	
Bearing strength at bolt holes	42
Combined shear and tension	41
Shear strength	38
Slip resistance	44
Tensile fatigue	48
Tensile strength	38
Direct tension indicators	
Washer-type, general	90
Inspection of	73
Installation using	66
Use of washers with	49
Drawing information	5
Bolting components	
Alternative-design	20
Storage of	18
Fatigue, tensile	48
Faying surfaces	23
Coated	24, 45, 77
Galvanized	24, 45
In pretensioned joints	23
In slip-critical joints	23
In snug-tightened joints	23
Uncoated	24
Galvanize	14
Galvanized bolting components	14
Galvanized faying surfaces	24, 45
General requirements	1
Geometry of bolting components	
Heavy hex nuts	8
Heavy hex structural bolts	8

Holes

Bolt	27
Long-slotted.	31
Oversized.	29
Oversized, use of washers with.	49
Short-slotted	30
Slotted, use of washers with	49
Standard.	29

Indicating devices

Spline end twist-off-type matched bolt assemblies	9
Washer-type.	9

Inspection. 70

Calibrated wrench pretensioning.	72
Combined method pretensioning	74
Direct tension indicator pretensioning	73
Pretensioned joints	70
Slip-critical joints	74
Snug-tightened joints.	70
Turn-of-nut pretensioning	71
Twist-off-type tension control bolt pretensioning	72

Installation. 60

Calibrated wrench method	64
Combined method	68
Direct tension indicator method	66
Pretensioned joints	61
Slip-critical joints	61
Snug-tightened joints.	60
Turn-of-nut method.	62
Twist-off-type tension control bolt method	66

Joints

Limit states in	37
Pretensioned	35
Faying surfaces in	23
Inspection of	70
Installation in.	60
Slip-critical	35
Faying surfaces in	23
Snug-tightened.	34, 60
Type.	32

Limit states in bolted joints 32

Loads	2
Combinations	2
Factors	2
Long-slotted holes	
General	31
Use of washers with	49
Nuts	
Geometry	10
Heavy hex	8
Specifications	8
Oversized holes	
General	28, 29
Use of washers with	49
Parts, bolted	23
Plies, connected	23
Pre-installation verification	52
Pretensioned joints	
Calibrated wrench pretensioning	55, 64, 72
Combined method	56, 68, 74
Direct tension indicator pretensioning	56, 66, 73
Faying surfaces in	23
General	35, 61, 70
Inspection of	70
Installation in	61
Use of washers in	49
Turn-of-nut pretensioning	55, 62, 71
Twist-off-type tension control bolt pretensioning	55, 66, 72
References	90
Requirements, general	1
Reuse, bolts	19
Shear, nominal strength	38
Short-slotted holes	
General	30
Use of washers with	49
Slip coefficient for coatings, testing to determine	77
Slip-critical joints	
Faying surfaces in	24
General	35

Inspection of	74
Installation in	61
Use of washers in	49
Slip resistance	44
Slotted hole, use of washers with	49
Snug-tightened joints	
Faying surfaces in	23
General	34
Inspection of	70
Installation in	60
Use of washers in	49
Specifications	
Bolts	6
General	3
Nuts	8
Twist-off-type tension control bolt assemblies	9
Washers	9
Spline end matched bolting assembly	9
Spline end twist-off matched bolting assembly	9
Standard holes	29
Standards	3
Storage of fastener components	18
Strength	
Combined shear and tension	41
Bearing	38, 42
Shear	38
Slip resistance	44
Tensile	38
Tensile fatigue	48
Surfaces, faying	23
Tensile design strength	38
Tensile fatigue	48
Testing, slip coefficient for coatings	77
Test reports	18
Turn-of-nut pretensioning	
Inspection of	71
Installation using	62

Twist-off-type tension control bolt assemblies	
Geometry	10
Inspection of	72
Installation using	66
Specifications.	9
Use of washers in	49
Uncoated faying surfaces	24
Use of washers.	49
Verification, pre-installation	52
Washers	
General	9, 49
Use of 144.	49
Washer-type indicating devices.	9
Zinc/aluminum coatings.	16

